

Madaster release notes

2023



This document and its contents have been compiled with the greatest possible care. Nevertheless, it cannot be ruled out that certain information is outdated, incomplete or otherwise incorrect. Madaster is not liable for any damage of any nature whatsoever arising from any use / consultation of this document and its contents and / or from the information obtained through this document, including but not exhaustive also information obtained through references mentioned in this document and / or hyperlinks.



Table of contents

1	Releases	4
2	Build 23297	5
2.1	New and changed functionalities.....	5
2.1.1	Materials merged with products.....	5
2.1.2	Cards in environmental tab reflects phase filter	5
2.1.3	Additional options in enrichment.....	6
2.1.4	Additional upload preset options	7
2.1.5	DGBC detachability export.....	7
2.1.6	New legal role and licenced database options	8
2.1.7	Folder type options for CRREM report.....	9
2.1.8	Other changes	10
2.2	Bugfixes.....	11
3	Build 22433	12
3.1	New and changed functionalities.....	12
3.1.1	CRREM and ESG Features.....	12
3.1.2	CRREM.....	12
3.1.3	Energy use of a building: B6.....	15
3.1.4	Splitting 3D and IFC	15
3.1.5	Sequestered carbon in A1-A3.....	15
3.1.6	Transfer fully enriched source file.....	16
3.1.7	Financial updates.....	16
3.1.8	Other changes	16
3.2	Bugfixes.....	17
4	Build 21775	18
4.1	New or Changed functionalities	18
4.1.1	Excel import/export for databases	18
4.1.2	Deactivating a building.....	20
4.1.3	Targets.....	21
4.1.4	Financial updates.....	22
4.1.5	Other changes	23



4.2	Bugfixes.....	25
5	Build 21116.....	26
5.1	New or Changed functionalities	26
5.1.1	Account and folder level dashboarding	26
5.1.2	Web-based passport.....	31
5.1.3	Other changes	35
5.1.4	Bugfixes.....	39
6	Build 20190.....	40
6.1	New or changed functionalities	40
3.1.1	Data settings and edit-layout.....	40
3.1.2	Other changes	46
3.1.3	Bug fixes	51
4	Build 19365	52
4.1	New or changed functionalities	52
4.1.1	New material passport options and design.....	52
4.1.2	Other changes	63
4.1.3	Bug fixes	79



1 Releases

Release	Build number	Release date
2023.1	19365	16 February 2023
2023.2	20190	23 March 2023
2023.3	21116	18 April 2023
2023.4	21775	1 June 2023
2023.5	22433	27 July 2023
2023.6	23297	1 October 2023

Table 1: list of releases in 2023



2 Build 23297

2.1 New and changed functionalities

2.1.1 Materials merged with products

It used to be possible in Madaster to either add a material or a product to a database:

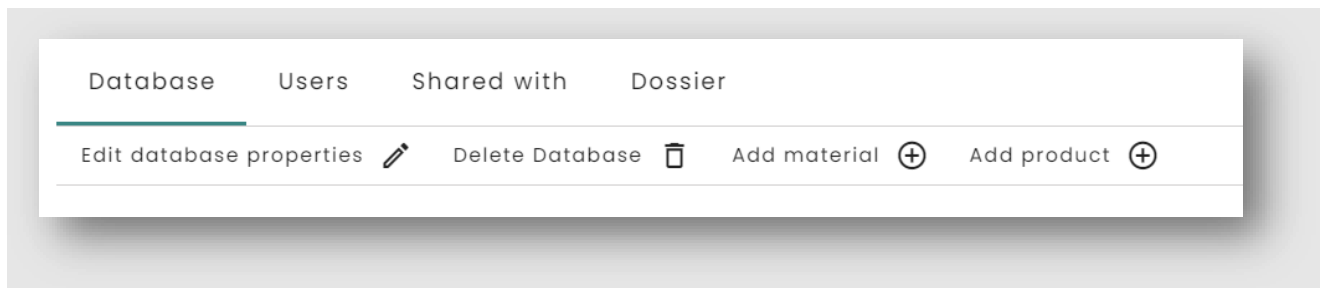

Since all the material options are present in the product they have been “merged”. It is now only possible to create a product. Existing materials have been migrated as volume products.

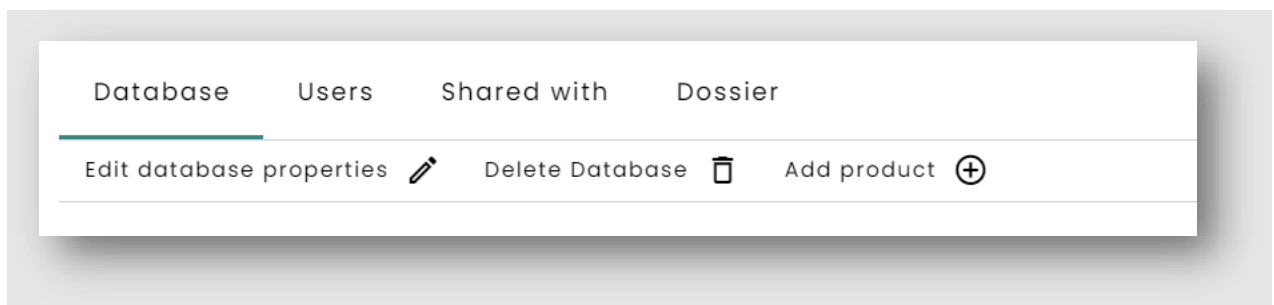

2.1.2 Cards in environmental tab reflects phase filter

As of this release the filter choice made for the phases in the environmental tab will also change the values in the cards shown in this screen:

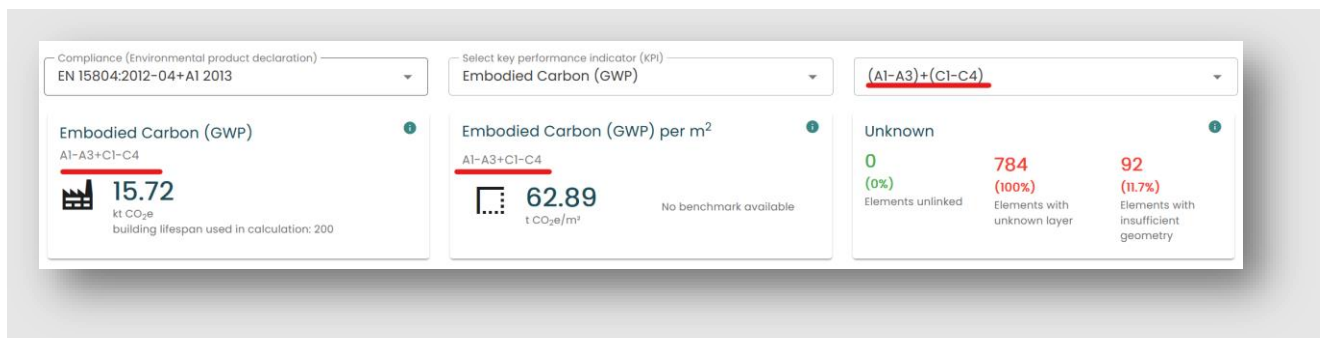



2.1.3 Additional options in enrichment

We've added an additional option for linking when an element is already linked in enrichment: to be able to relink all elements previously linked to the same product. This can be for example useful when a file is enriched to a greater level of detail.

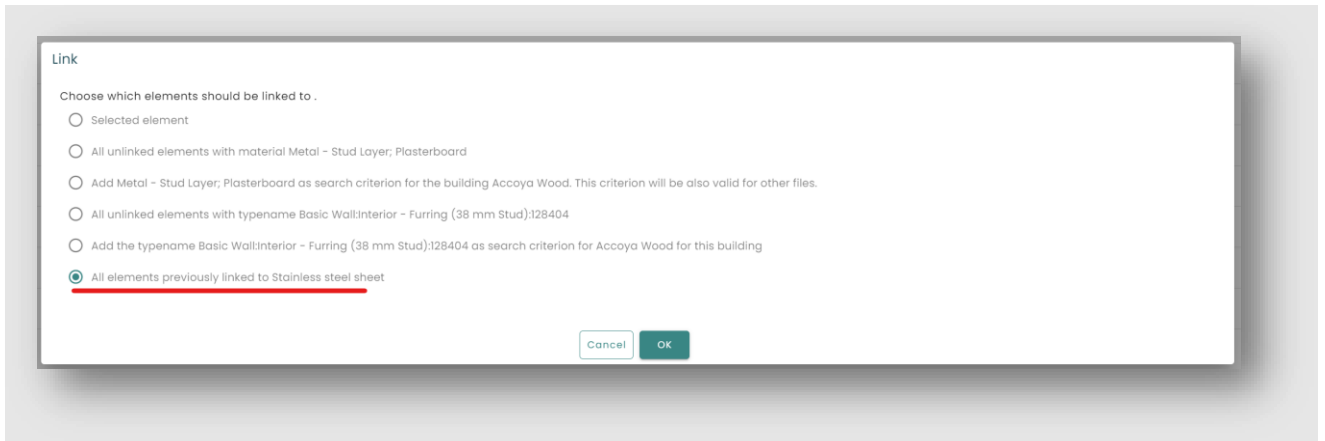

Additionally, there are new filter options:

- It is now possible to filter on whether an element has subelements/children
- It is now possible to filter on the product

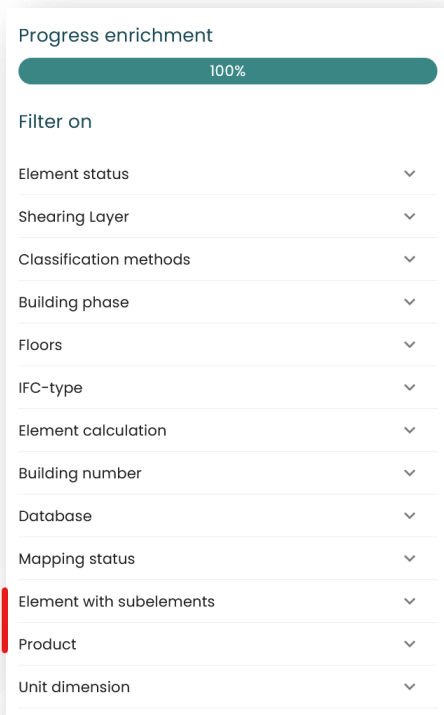



2.1.4 Additional upload preset options

It is now possible to use three new properties in the upload presets:

Property Set for : MadasterId	Property name for : Madaster Id
Property Set for : external Id	Property name for: external Id
Propertyset for Article number (Product code)	Property name for: Article Number (Product code)

2.1.5 DGBC detachability export

For the Netherlands we've built the DGBC detachability export; which can be found as an option when choosing to generate a material passport:

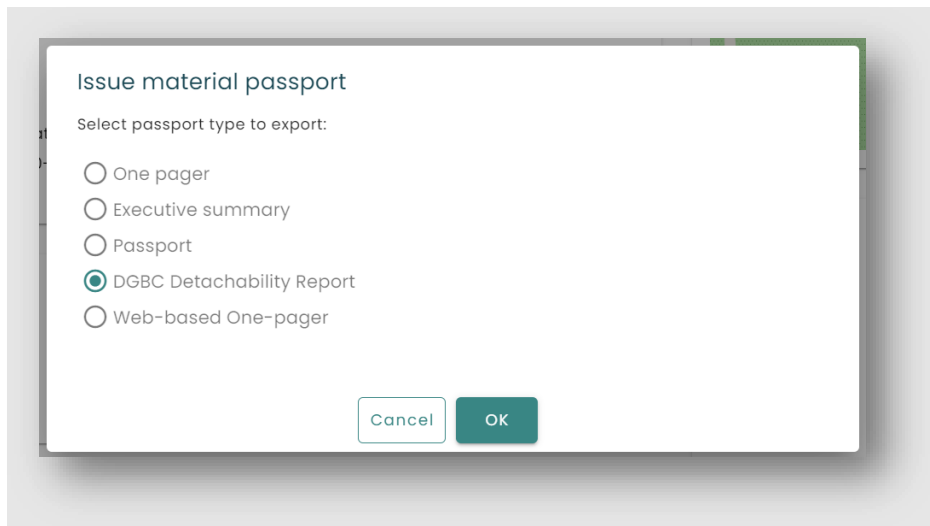



2.1.6 New legal role and licenced database options

In preparation for further development of sharing data between producers and accounts that use products from these producers we've introduced a new legal role and a menu-option in the account to see licenced databases. Note that for now this does not add any functionality.

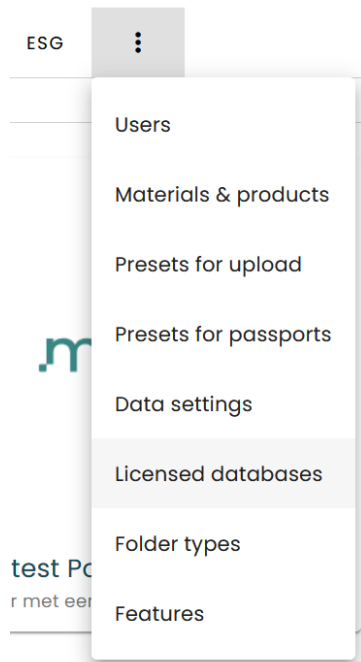
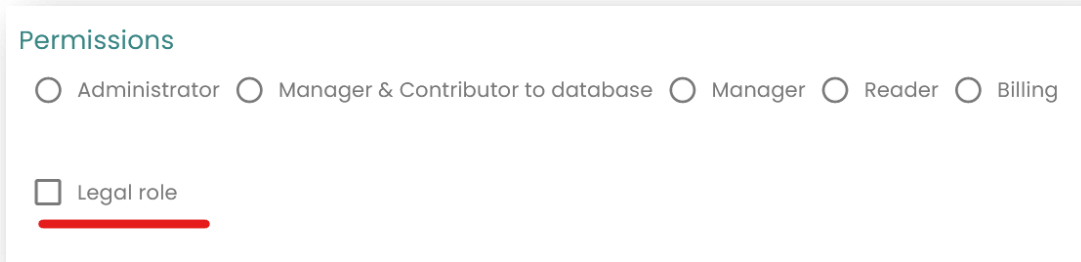



2.1.7 Folder type options for CRREM report

The recently released CRREM feature can generate the CRREM Excel on folder and account level. In order to prevent unnecessary file generation this can now be excluded from the folder. This is a folder type setting:

New Folder type

Name * Description

Plural Name

Foldertype allowed directly under account?

Buildings can be added in this folder type

Does folder of this folder type requires an address?

Folder of this type is a region defined by spatial coordinates?

Allow search criteria

CRREM report generation possible

Legal role and approval of database licensing possible.



2.1.8 Other changes

- When selecting an LCA phase on the environmental dashboard on account and folder level you will now also get to that phase of a building when clicking in the chart.
- Favourites are now also shown on 'My dashboard'.
- The 'duplicate item' button has been replaced by an 'import product' button when selecting an item from an external database.
- A new field for 'BREEAM registration number' has been added to the building form.
- The color for 'Elements without geometric dimensions' have been changed because it is not necessarily wrong to have elements without geometric dimensions.
- We've updated the Uniclass codes and extended the mapping from Uniclass to RICS.
- On the environmental tab we've added new phase filter options for:
 - C3-C4
 - (A1-A3) + (C3-C4)
- In the technical annex for the passport the product lifespan has been added.
- We've added a new KPI for the IPB 2009/1:2022: Greenhouse gas emission per m² per year.
- The '+' button has been moved to the right in the edit lay-out screen
- For Switzerland the following certification fields have been added to the building:
 - SGNI
 - Minergie
 - SNBS
- The 'Weight' column has been removed from the excel import template.



2.2 Bugfixes

- Enrichment utilizing the '2BA' database wasn't working correctly; this has been fixed.
- When you only have reader rights on an object you were not able to see it when it was deactivated. This has been fixed.
- With read-only rights you could still see some buttons on the account level for which more extensive authorizations are required; this has been solved.
- It is no longer possible to move a folder to be its own subfolder.
- Detailed information of included elements in the mass and environmental tabs of a building was not always shown correctly, which was fixed.
- The environmental KPI 'Materials for energy recovery (MER)' was shown in the unit MJ which is now corrected to kg.
- It is now properly possible when creating a new product to immediately add a certificate for sustainability.
- The classification would not always show when viewing element details in the mass tab. This was solved.
- In enrichment, when selecting an element and changing the filters the no longer shown element could still be selected, which was fixed.
- Missing translations have been added.
- Retrofit actions in the CRREM screen were not properly processed, this has been fixed.
- Cancelling deleting a manual financial line on a product would still result in the line being deleted. This was solved.
- It wasn't possible to save the 'Gross internal area' on an UMS object; this was fixed.
- Transferring already enriched sourcefiles could sometimes fail; this has been fixed.
- When going directly from the starting dashboard to the 3D view of an object in the circularity tab the colors of the 3D model would be gone, which has been fixed.



3 Build 22433

3.1 New and changed functionalities

3.1.1 CRREM and ESG Features

This release sees the introduction of the ESG feature in general and the CRREM feature specifically. Because in the future we expect to introduce multiple features related to ESG we made it possible to first separately activate the ESG features and then choose the features related to this tab individually.

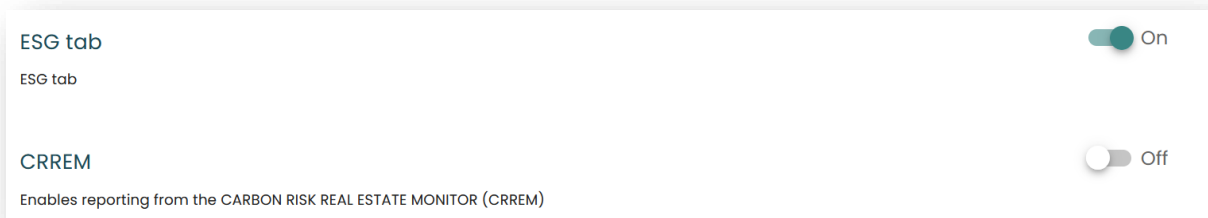
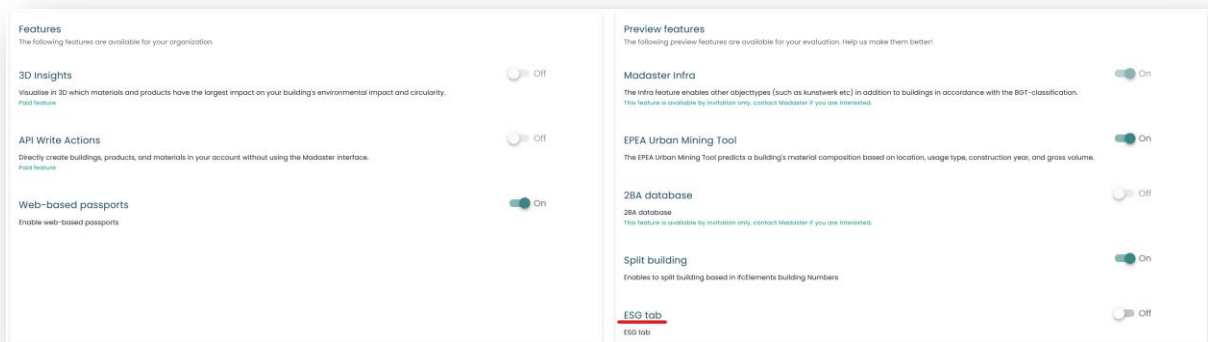

For now the only option for ESG is the CRREM feature. CRREM stands for the Carbon Risk Real Estate Monitor which is a tool to monitor when an asset gets 'stranded'. Explaining the whole tool or what stranded assets are is beyond the scope of these release notes, but [it is explained on their website](#).

3.1.2 CRREM

CRREM is a paid feature. After activating the feature the option to generate a CRREM report will be available from the ESG tab.

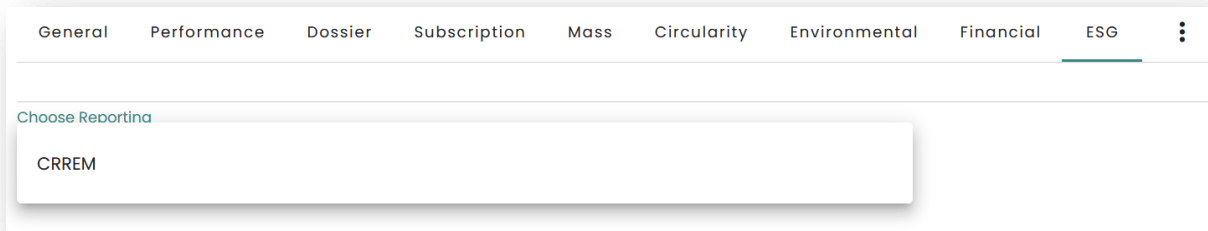

The CRREM report can be generated on multiple levels. The excel report is available in the dossier on folder or account level, where it is also possible to upload a new version if there is already a CRREM file. This means it is also possible to edit a lot of buildings at once in the excel and then upload that information instead of editing each building separately in the UI. It is still possible to add the information that is necessary for CRREM through the UI in the individual buildings.

3.1.2.1 CRREM on account and folder level

When using the CRREM feature on account or folder level there are the following options:

- When there is no CRREM file it is possible to make an export for the buildings in the file or folder
- If there is a CRREM file present it is also possible to upload a new version of the file

3.1.2.2 CRREM on the building level

CRREM needs additional information for each building to be able to do the assessment. Some of these fields are on the building itself, but most of them concern the energy use of a building. We have added a separate screen from the CRREM reporting page for that on a building:



 Show settings

Choose Reporting

CRREM

Settings

Input

User-defined settings

General

Reporting year Gross Asset Value € Months of data

Building characteristics

Air conditioning Average annual vacant area

Total energy procurement

Electricity

Usage kWh Data Coverage m² Maximum Coverage m²

Natural gas

Usage kWh Data Coverage m² Maximum Coverage m²

Fuel Oil

Usage kWh Data Coverage m² Maximum Coverage m²

District heating

Usage kWh Data Coverage m² Maximum Coverage m²

District cooling

Usage kWh Data Coverage m² Maximum Coverage m²

Other energy consumption type 1

Type Usage kWh Data Coverage m² Maximum Coverage m²



3.1.3 Energy use of a building: B6

With the addition of energy fields introduced by CRREM we can calculate the energy use in the lifecycle of the building (B6) for GWP. Note that this is only fillable when the CRREM feature is enabled.

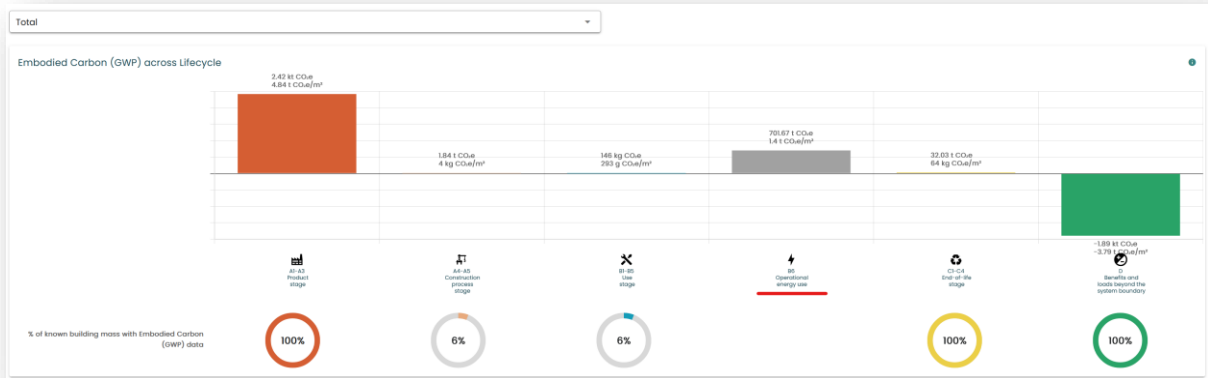

3.1.4 Splitting 3D and IFC

In Madaster it is possible to split a building if the ifc file contains the correct information. It used to be that both the ifc and the 3D model of the splitted building would still contain the information of the whole set instead of only the information of the splitted building. This has now been changed so that it only shows the IFC and 3D information of the splitted building. In cases where we cannot we do not show the 3D model and we disable the option to download the ifc file.

3.1.5 Sequestered carbon in A1-A3

Some products contain sequestered carbon, which can result in a negative GWP in the A1-A3 phase. We have included this now in the building LCA so that you can see the effects of this sequestered carbon in the lifecycle of the building.

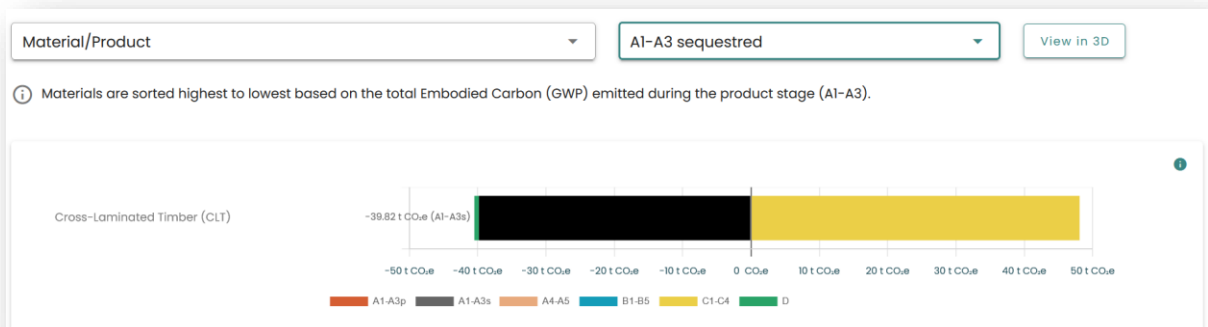



3.1.6 Transfer fully enriched source file

It is now possible to transfer an enriched file to an existing building so that it is possible for separate parties to enrich their files and combine them in one place.

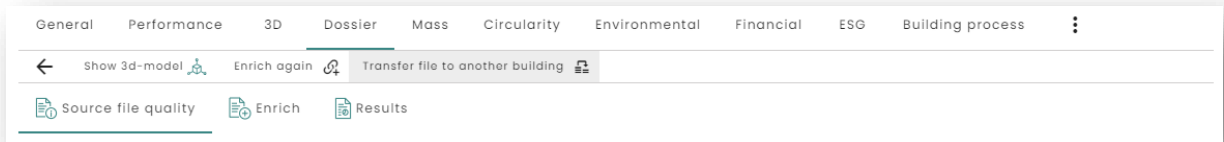

3.1.7 Financial updates

- The currency exchange rated from the existing API stopped working. We rebuild this so it connects to the ECB data for Euro-USD, Euro-GBP and Euro-CNY
- A number of pricesets have been added, corrected or changed

3.1.8 Other changes

- The recently introduced field for gross internal area has been added to the passport
- When you're on the performance tab and you are recalculating the building the dashboard will refresh once the calculations are done



3.2 Bugfixes

- Downloading some documents from the dossier didn't work properly anymore; this has been fixed
- Fixed an added url in the dossier not opening
- In the calculations for the B4 phase it could happen that products were wrongfully added multiple times, which has been corrected
- Deleted objects could count towards the number of objects in use; this has been solved.
- Refreshing the browser on the performance tab could result in a blank page. This is fixed.



4 Build 21775

4.1 New or Changed functionalities

4.1.1 Excel import/export for databases

This release functionality has been introduced to be able to export or import excel files from or to your database. This new functionality is only available on request.

From the dossier tab of a database this option has been added:

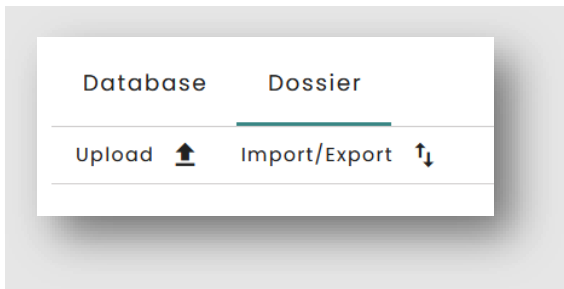

Using the button shows the different templates available for importing and exporting.

4.1.1.1 Exporting data

Exporting data can be done with the following options:

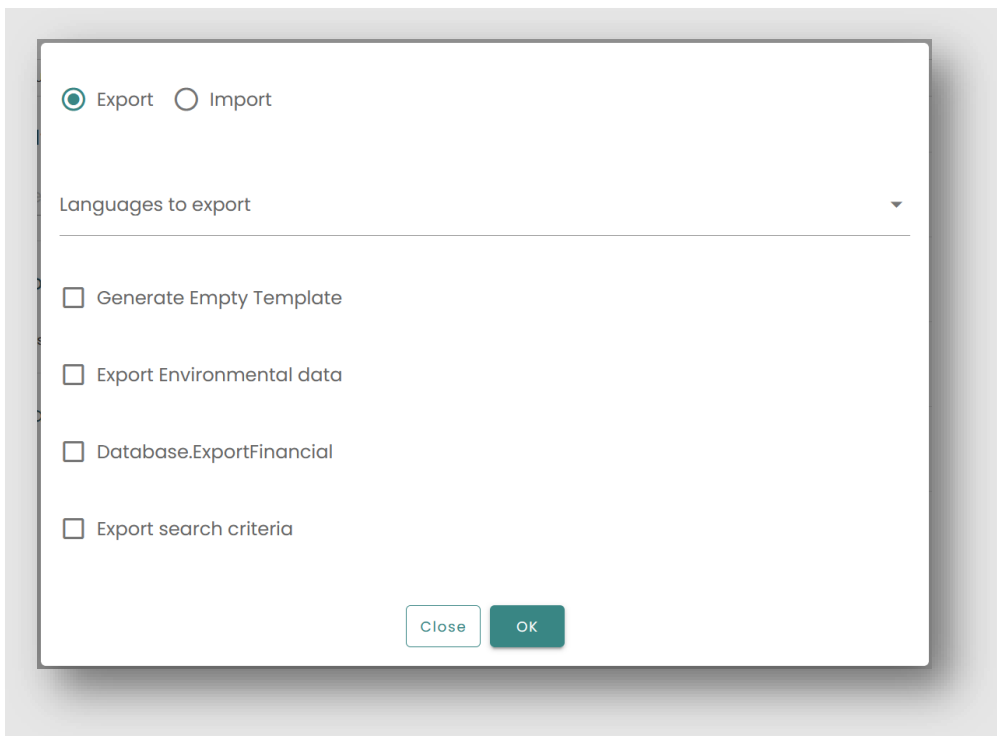



All of the options will place the excel file in the dossier of the database. These options are:

- For which languages you want to export the data, multiple options are possible.
- Generate empty template: this will create an empty excel template which can be used to fill in and upload to get all the data in more easily.
- Export environmental data: this will export all the environmental data from the records in the database.
- Export financial data: this will export all the financial data from the records in the database.
- Export search criteria: this will export all the current search criteria of the database.

Please note that only products will be exported or imported, and not materials.

4.1.1.2 Importing data

Importing the data only works when the excel is structured in the same way the export templates are. The following options are available for import:

Export Import

Import basic data (products sheet)

Import circularity and detachability data

Import environmental data

Import search criteria

Select file *

Close OK

The following data can be imported:

- Regular product data, which are also the fields shown on the product information tab in the database.



- Circularity and detachability data, corresponding to the data shown on the circularity tab.
- Environmental data, which is the data as shown in the environmental tab
- Search criteria

It is possible to select multiple of these.

4.1.2 Deactivating a building

It is now possible to deactivate a building:

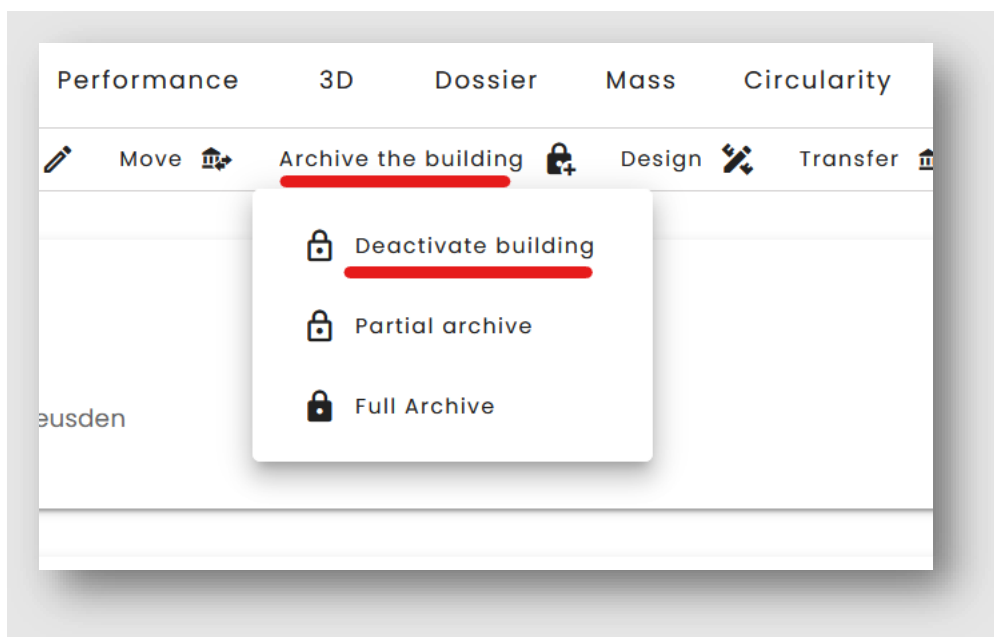

Which is a far quicker way to change an existing building into an 'archived building'. It is also possible to immediately deactivate the building in your own account when you transfer a building.



Choose account

Building Name

Dorpsstraat 1

Deactivate original building

Aan de Stegge Twello

4.1.3 Targets

In the data settings on either account, folder or object it is now possible to add your own targets for a given KPI. This does not as of yet show up in the dashboarding or reporting, so stay tuned for further updates on this functionality.

Data settings

Select preferences

Targets

MCI

50 %

Material Flows

+ Add target

X

Key Performance Indicator

Input Primary

25 %

Scarcity

%

Detachability

%

Environmental

+ Add target

Net Present Value (NPV)

%

Current value

%

Save



4.1.4 Financial updates

This release a number of sources for prices of materials have been updated. This concerns the following:

- Wood
- Rubber
- Platinum
- Palladium
- Plastics
- Glass
- Sand
- Asphalt
- Gravel
- Gypsum
- Stones

The fallback for pricing has been made more granulated, so that for example not all metals with unknown pricing will default to the price for Steel scrap. The price sets connected to the material families can be seen in the platform now as well:

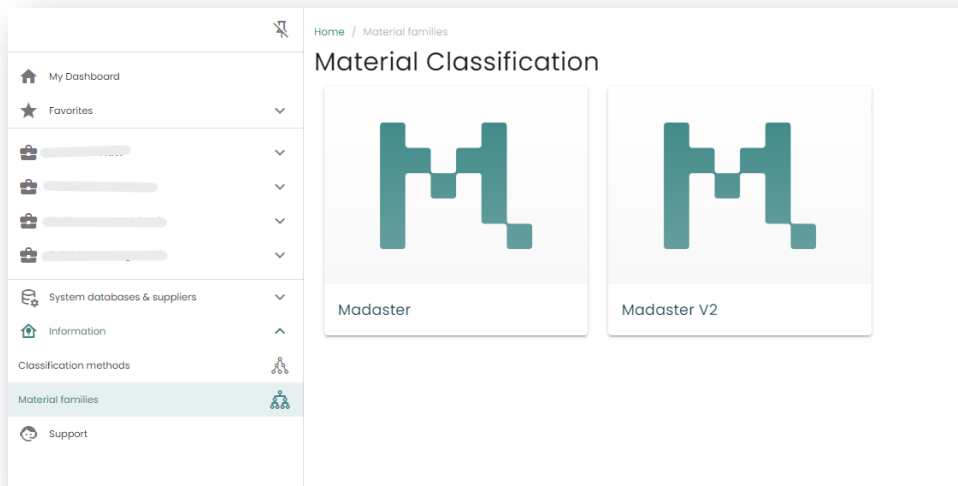



Home / Material families / Madaster V2

Madaster V2

↑	Name	Default priceset	Last known value
	E - NATURAL STONE	Mixed stones	€0.057/kg
	E1 - Igneous rock	Mixed stones	€0.057/kg
	E2 - Marble	Mixed stones	€0.057/kg
	E3 - Limestone (other than marble)	Mixed stones	€0.057/kg
	E4 - Sandstone, grit stone	Mixed stones	€0.057/kg
	E5 - Slate	Mixed stones	€0.057/kg
	E9 - Other natural stone	Mixed stones	€0.057/kg
	E - PRECAST WITH BINDER	Concrete	€0.034/kg

4.1.5 Other changes

- The preset for passports has been made more clear in the UI when generating a passport and if there is a custom preset this one is now chosen by default.
- Icons giving more information about selected databases have been implemented on more places and extended:



- The recalculate button has been added to more places on a building
- When searching in a database an going back to the overview the last search term will be kept



- The fields 'gross internal area' and 'gross asset value' have been added on the building form
- The filter for delivered date on the map on a account or folder has been changed from a slider to start and end years. It is now also possible to filter on a year in the future:

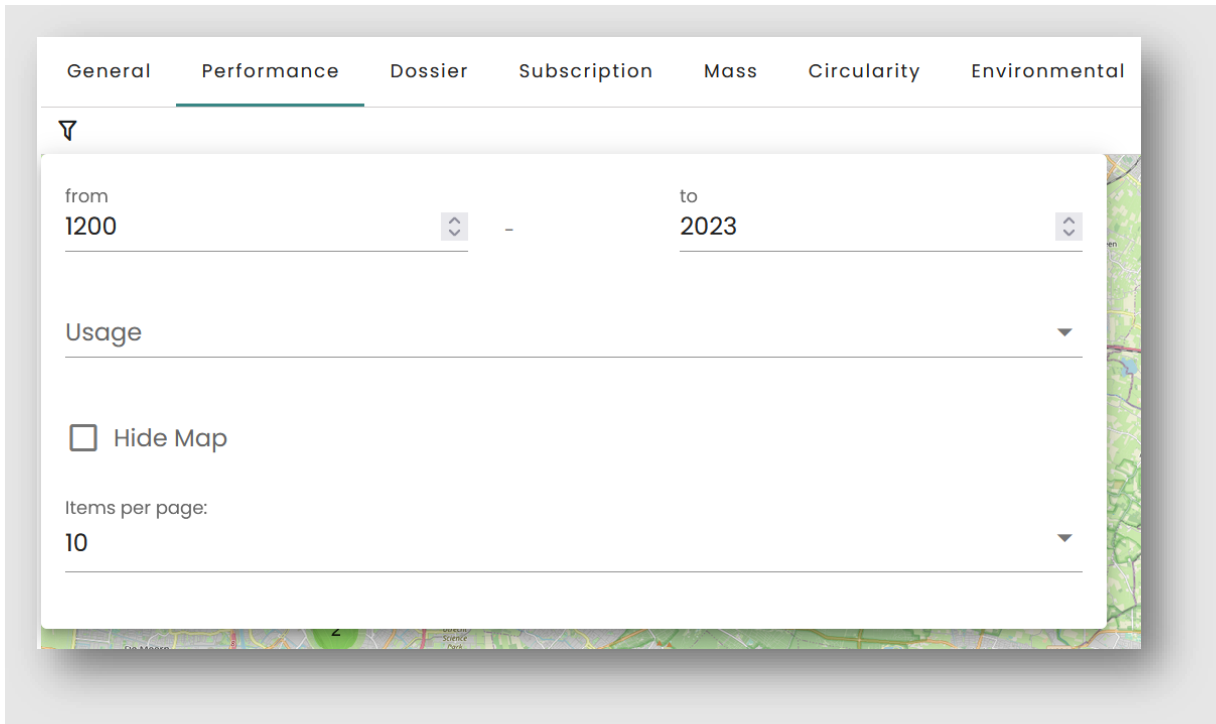



4.2 Bugfixes

- The sorting arrows for the building pictures were not visible on a black background. This has been fixed.
- Property values in the 3D viewer could go offscreen, which has been corrected.
- Fixed a bug where the map could overlap with the topbar
- When saving a passport preset without filling all the required fields the form would close and nothing would be saved. This has been changed so that a message is shown.



5 Build 21116

5.1 New or Changed functionalities

5.1.1 Account and folder level dashboarding

In this release dashboarding details for account and folder level have been introduced. This means it is now possible to see how the building scores on different KPI's on for example a whole portfolio.

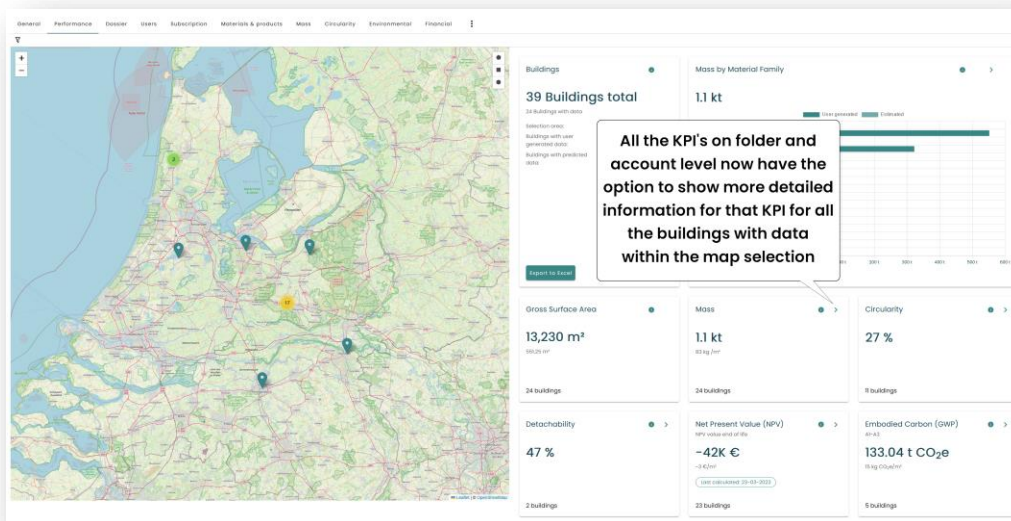

Figure 1: the performance tab on an account with the default settings for KPI's shown

It is also possible to go straight to one of the new tabs in the folder or account

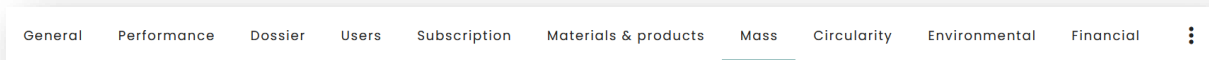

Figure 2: the new tab structure of an account with the new mass, circularity, environmental and financial tabs. These new tabs have also been added to folders.

The KPI's shown are dependent on which have been chosen in the edit lay-out settings for the user. If no specific lay-out has been chosen the default KPI's from the Madaster platform will be shown.



5.1.1.1 The Mass tab and general dashboarding options

The mass tab on folder and account level will show the map on the left and on the right an overview of all the buildings with data for the chosen KPI within the map selection:

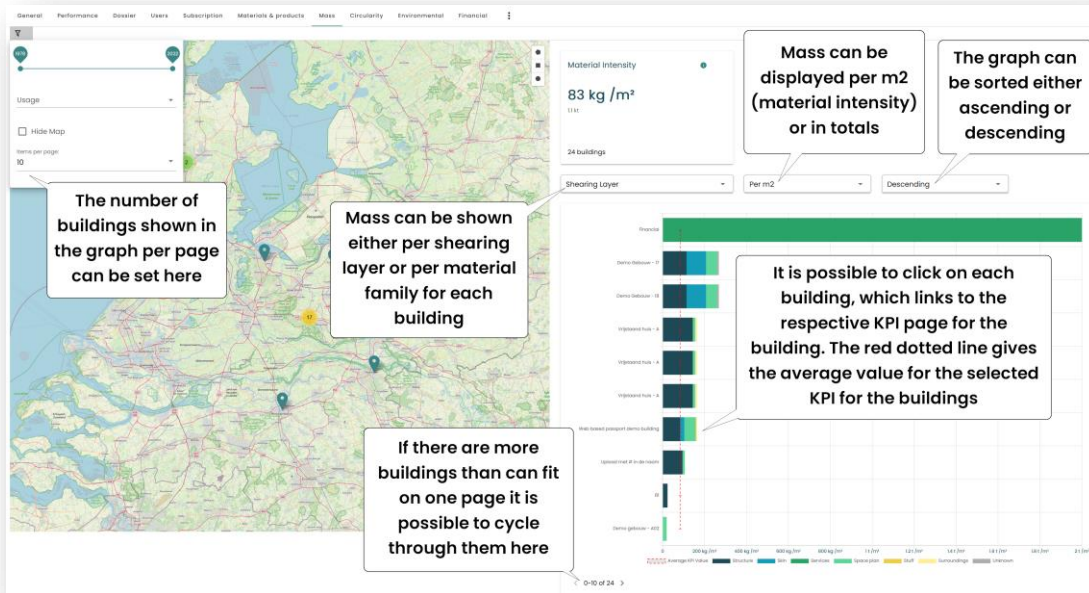

Figure 3: an example of the mass tab on an account

Note that a number of options will be available on every tab, whether it is mass, circularity, environmental or financial. These are:

- Paging: setting the number of items per page and cycle through them.
- Clicking the building in the graph, this will for all tabs and KPI's result in navigating to the selected KPI page of that specific building.
- The average is shown for a lot of KPI's, but not all of them.
- Sorting the graph ascending or descending.
- Hovering over the bars in a chart will show a tooltip giving more specified information.

For mass specifically the following options are available:

- The bar for each building can be stacked showing either the mass or material intensity for each shearing layer or the mass or material intensity for each material family.
- The mass can be shown per m², which is the material intensity, or for the total mass of the whole building. This will also change the card above the chart.



5.1.1.2 The Circularity tab

The circularity tab on account or folder level has the following options:

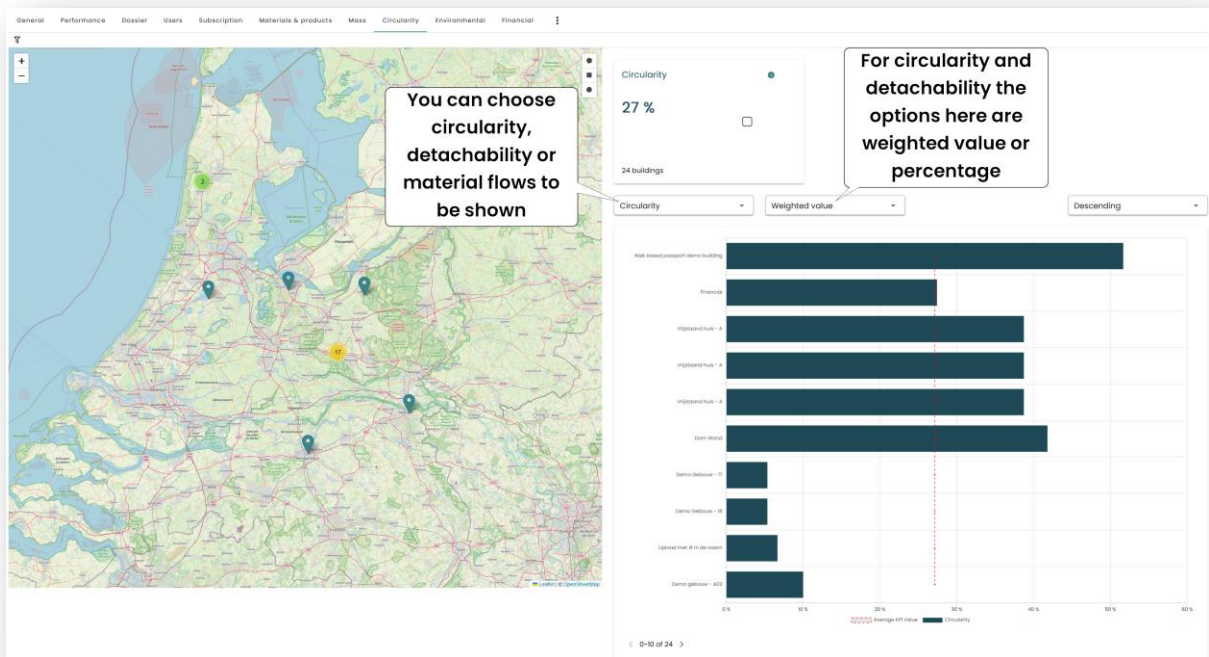

Figure 4: the new tab for circularity on an account

For the circularity and detachability information:

- When choosing the percentage the buildings will be sorted by their respective KPI scores; either the MCI or their detachability score.
- The weighted value will sort the buildings by their KPI score multiplied by their mass. This gives insights into which buildings have the largest impact on the aggregated circularity score of the selected buildings. The graph itself will still show the actual MCI or detachability score.



For the material flows there are slightly different options:

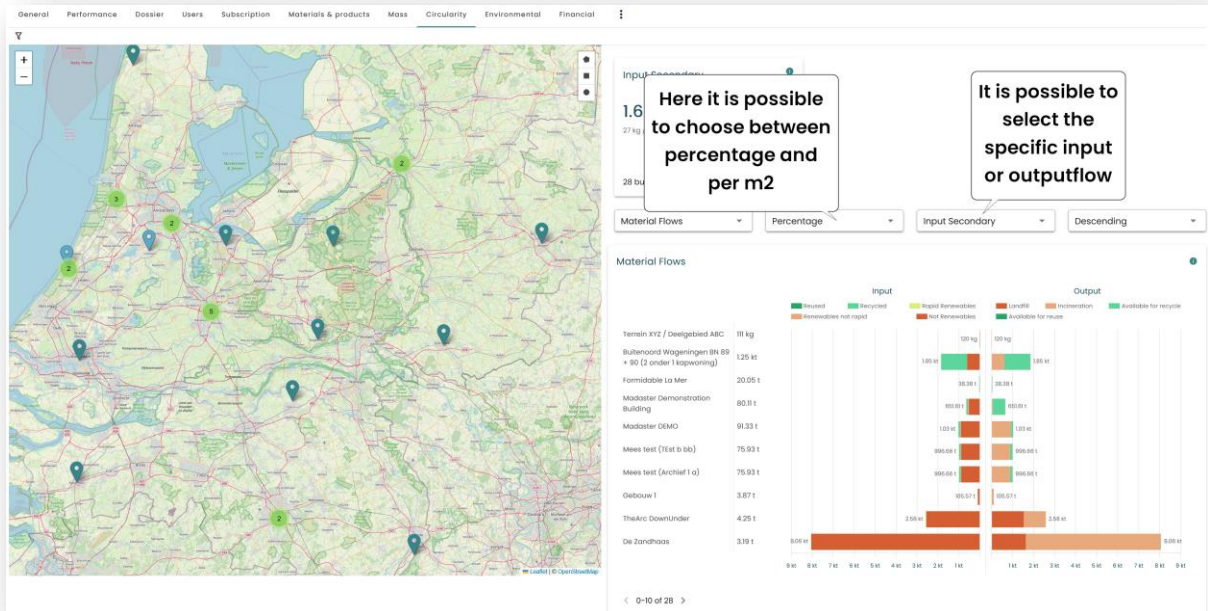

Figure 5: the material flows on the circularity tab on an account

- Percentage orders the buildings by which building has the highest percentage of the chosen material flow. It is also possible to order by m².
- The material flows can be ordered by the following:
 - Total mass
 - MCI
 - Input Primary
 - Input renewables sustainably produced
 - Input Secondary
 - Output Waste
 - Output recoverable



5.1.1.3 The Environmental and financial tabs

As elsewhere in the platform the environmental KPI's are based on compliance. Furthermore, it is possible to choose from a set of LCA phases or combination of phases. It is also possible to sort based on the totals or by m².

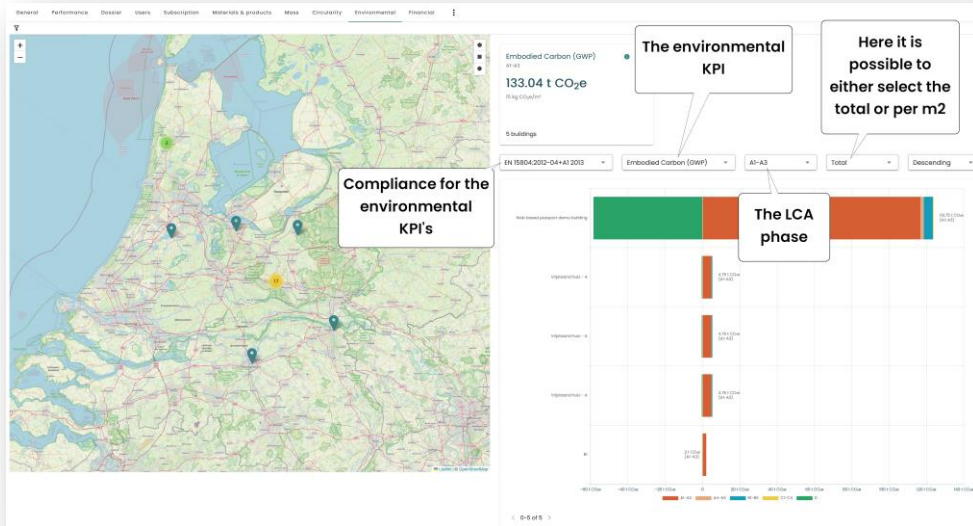

Figure 6: the environmental tab on an account

The financial tab shows the residual value of the buildings in terms of material value. You can choose either the Net Present Value, for which a stacked bar with the layers of Brand is shown, or the Current Value, which shows the material families.

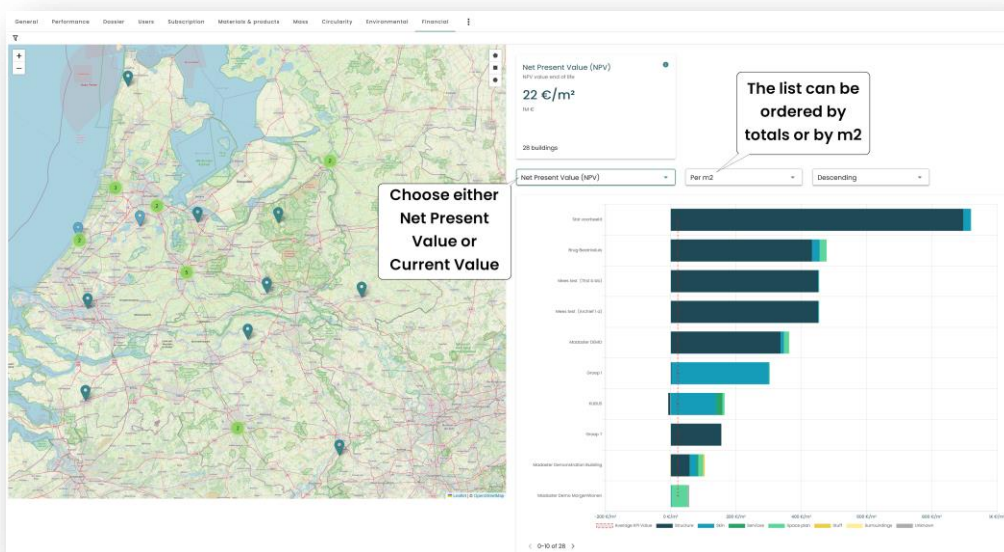

Figure 7: the financial tab on an account



5.1.2 Web-based passport

The web-based passport is a one-pager material passport that is published on the internet and can be shared by either directly sharing the link or via social media.

5.1.2.1 Generating a web-based passport

To generate a web-based passport the 'issue material passport' on a building is used.

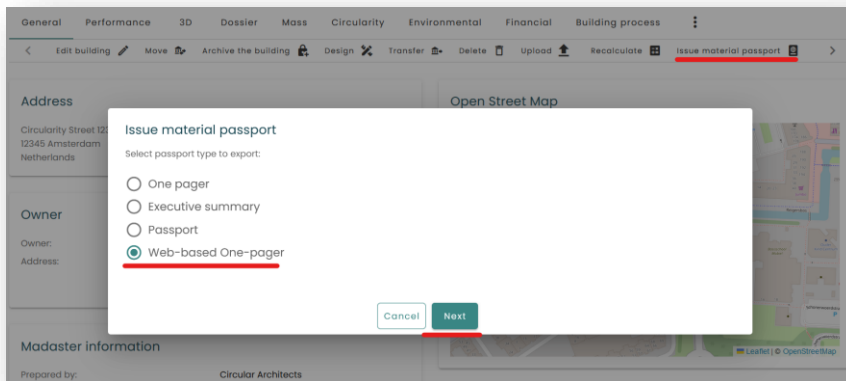
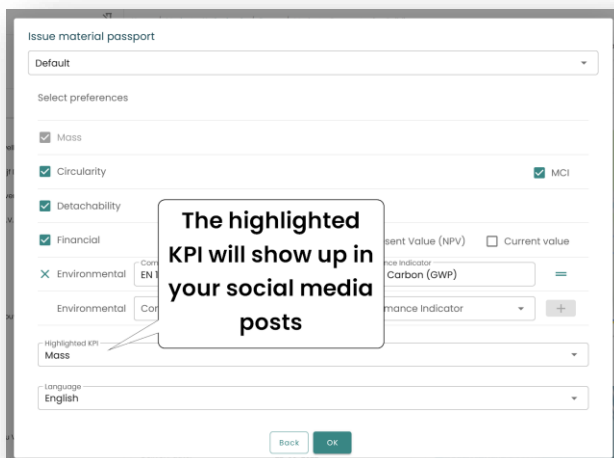

Figure 8: selecting to issue a material passport on the building page

The options for what to show on the web-based one-pager material passport are the same as for the regular one-pager with the addition to select a highlighted KPI. This KPI is the one which will show up on the preview in the social media post that are made using this passport. As with the regular one-pager, only a maximum of four KPI's (excluding mass) can be chosen.





After selecting the preferred options a notification will appear

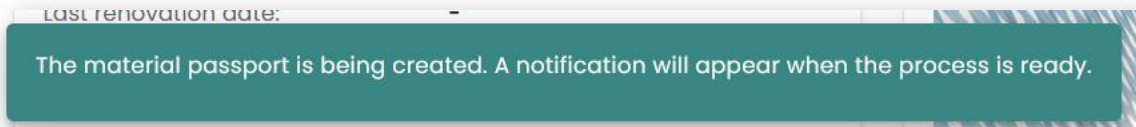

Followed by an alert once the passport is ready

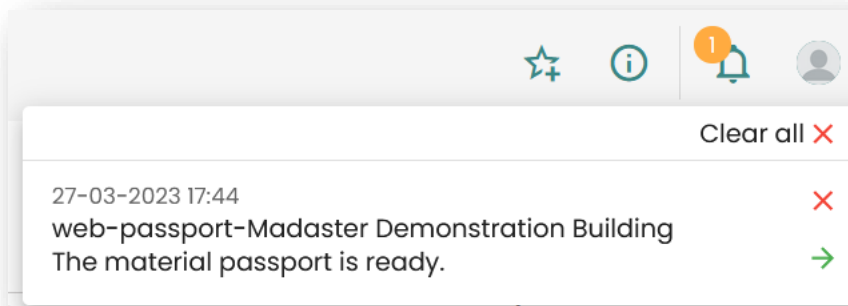

5.1.2.2 Using the web-based passport

The web-based passport will appear in the dossier of the building, from where it is possible to open the link, share it on social media or delete it.

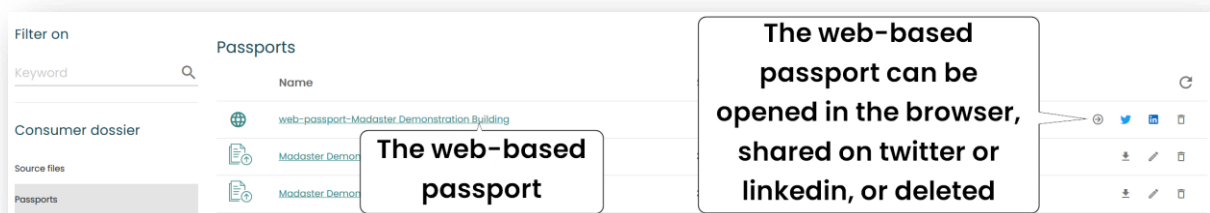

Opening the link will show the web-based passport in the browser. This is a responsive design, meaning it will scale to the size of the screen and therefore fits on both a bigger screen and a smaller one, such as on a mobile device.

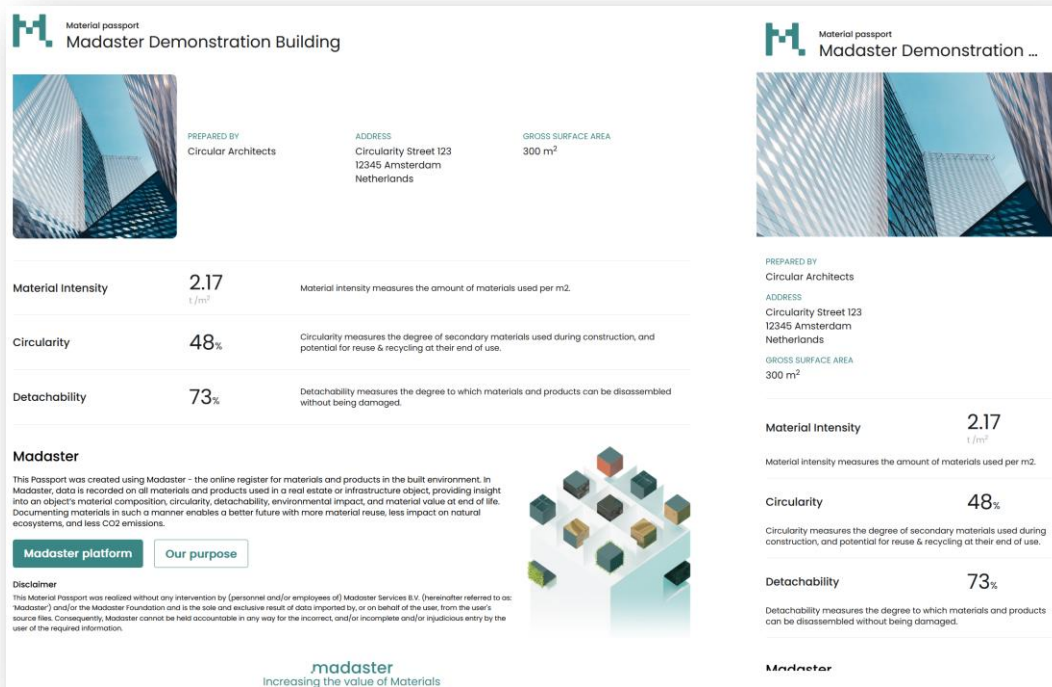
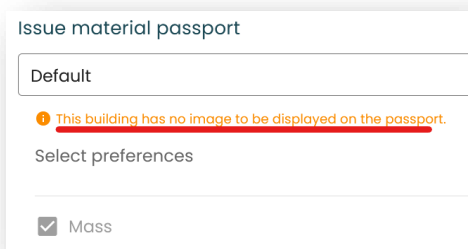

Figure 9: the web-based passport in different sizes. Left on a bigger screen, right how it looks on a mobile device.

Some remarks about the web-based passport:

- Generating web-based passports can be disabled by disabling the web-based passport feature.
- You can only have one web-based passport for a building, creating a new one will overwrite the existing one.
- When you archive or transfer a building the web-based passport will not be copied.
- Deleting the building will also delete the web-based passport.
- The picture chosen for the passport is the first picture on the building. If the building has no pictures a warning will be shown when a web-based passport is generated





- Like the other passports, data settings can limit the KPI's to be used in the passport.
- It is possible to define a passport preset for a web-based passport
- Deleting the passport will result in a 404 when navigating to the URL

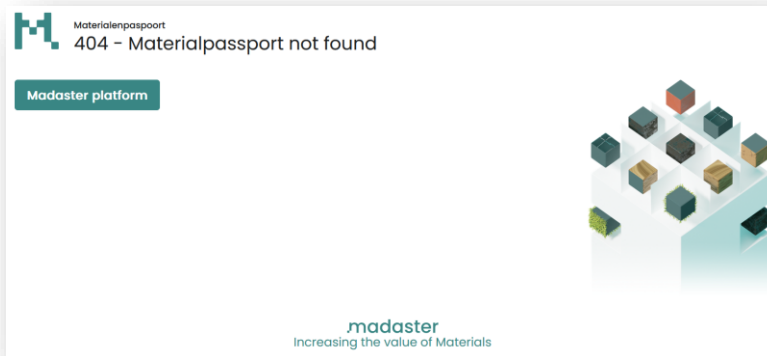

- Using the sharing buttons in the dossier will open either Twitter or LinkedIn. The preview card used in the social media post shows the chosen highlighted KPI. The card on the post links to the whole web-based passport:





5.1.3 Other changes

5.1.3.1 UI changes

5.1.3.1.1 Show unavailable data when generating a passport

If certain data has been made unavailable in data settings this now also shows up when generating a passport:

Issue material passport

Default

Select preferences

Mass This data is not allowed to be shown

Circularity ^o MCI ^o Material Flows ^o Scarcity ^o

Detachability ^o

Financial ^o Net Present Value (NPV) ^o Current value ^o

Environmental EN 15804:2012-04+A1 2013 AI-A3 Embodied Carbon (GWP) =

Environmental +

Language
English

Back OK

5.1.3.1.2 Notifications

It is now possible to dismiss all notifications at once. Furthermore, if you dismiss one notification and there are more the popup will not close.

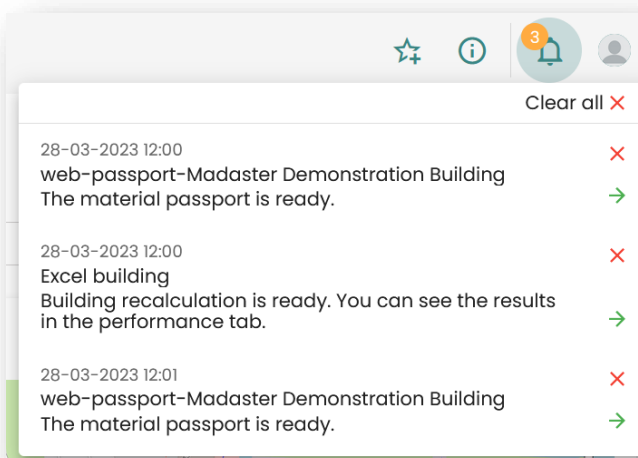



5.1.3.1.3 Focus on missing fields on building form

When you create or edit a building and try to save without one of the required fields not filled in the screen will now focus automatically on the location of the missing fields.

Usage*
Detached house

Override the demolition costs (default: 64 euro/m²)

Gross Surface Area*
300 m²

Building phase*
The Building phase field is required

Delivery date*
The Delivery date field is required

5.1.3.1.4 Color difference between user generated and estimated data

When the difference is shown between user generated and estimated data the colors were very similar and it was difficult to distinguish. The colors have been changed.

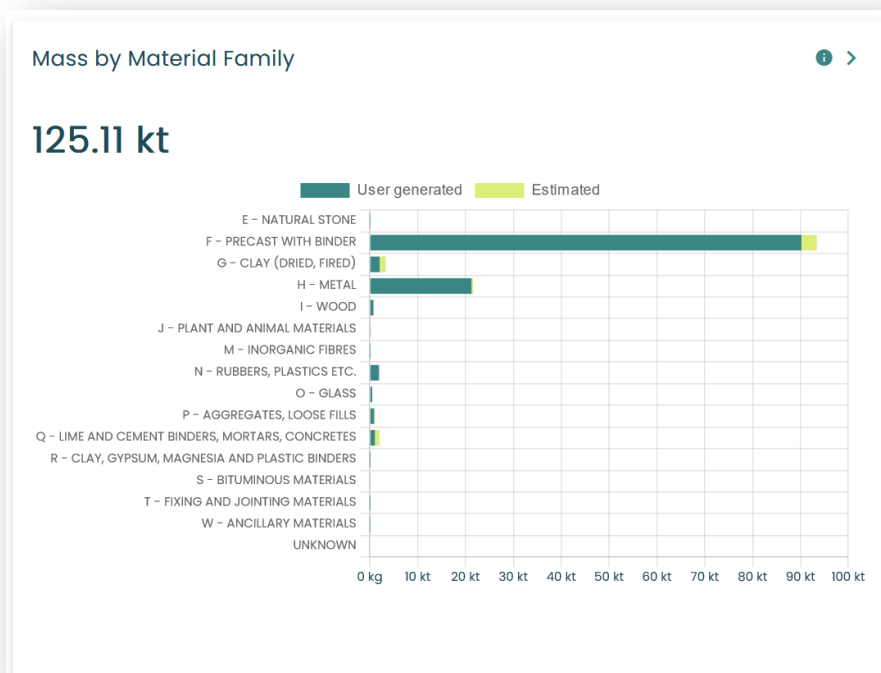



5.1.3.1.5 Sort or select all filters

When using the material & products tab on an account or folder, when using a database or when linking an element from enrichment it is now possible to sort the filters alphabetically or to select/unselect all of them.

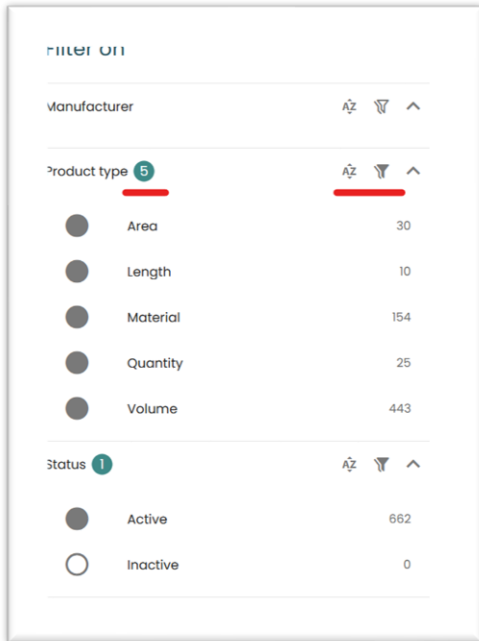

5.1.3.1.6 Sorting of pictures and adding a screenshot picture

It is now possible to sort the pictures on a building by using the arrow icons when editing a building. Also, taking a screen capture from the 3D model will now add the picture without a need to refresh.





5.1.3.2 Support for IfcMaterialConstituentSet from the IFCv4 standard

In the IFCv4 standard the property IfcMaterialConstituentSet can be used to define the material and optionally the fraction of that material within a single IFC element. When this is used in an IFC file Madaster will now support this.

5.1.3.3 Material flows now available as KPI in edit-layout

When defining which KPI's to show in the edit lay-out options it is now also possible to add the material flows to building, folder or account level.

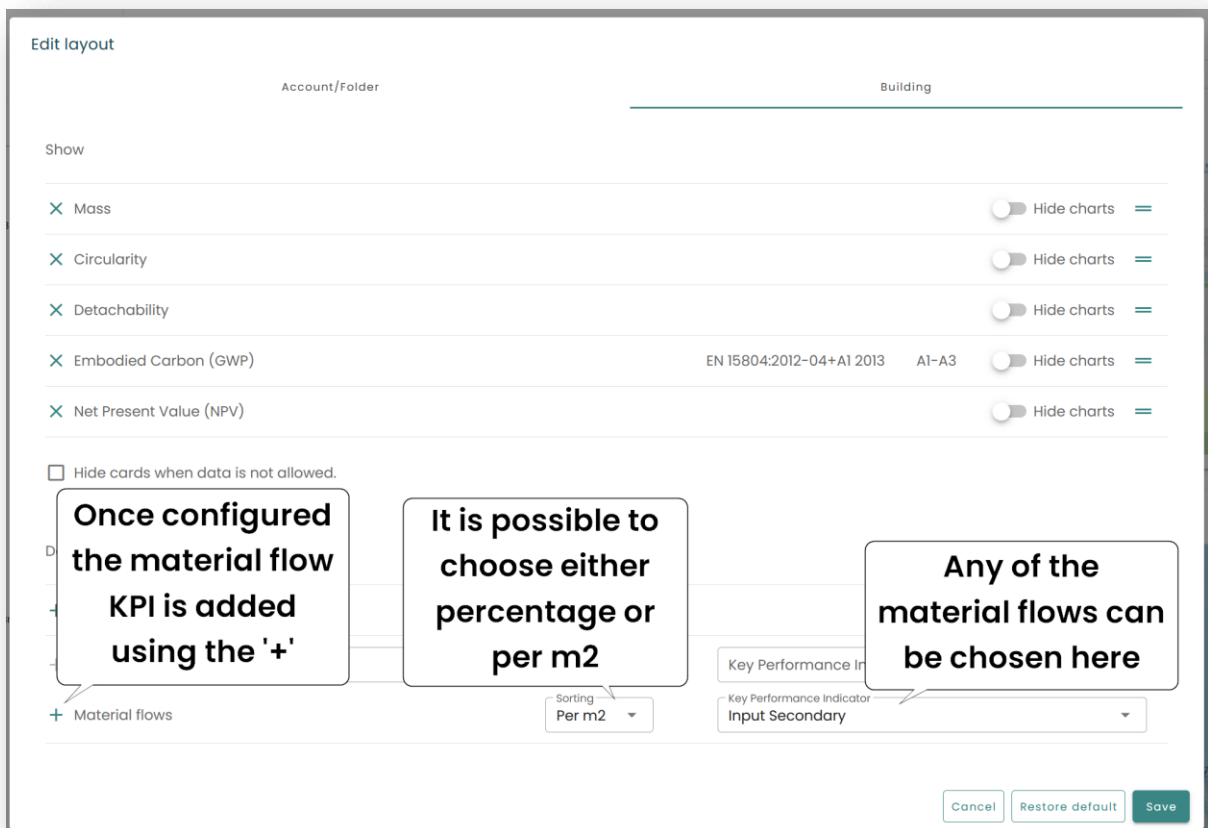



5.1.4 Bugfixes

The following bugs have been resolved:

- Archives, designs and splitted buildings were not shown correctly in the list view on accounts and folders. This has been fixed.
- When cancelling a transfer a notification would appear that the process was scheduled. This wrong notification has been removed.
- The color representation on the percentage of elements linked after enrichment could be wrong. That has been corrected.
- When archiving or splitting a building and generating a passport the passport would not appear, which has been fixed.
- Selecting a database in the navigation could result in it looking like multiple databases were selected. This is fixed.
- An empty template used as a source file would result in infinite loading in the enrichment screen. This is fixed.
- When linking an element in enrichment to a material it was possible to match it on typename. This option has been removed.



6 Build 20190

6.1 New or changed functionalities

3.1.1 Data settings and edit-layout

This release new functionality has been added which enables administrators to choose which data to show for their buildings and also for a user to decide which KPI's they want to see.

3.1.1.1 Data settings

On an account, folder or building it is now possible as an administrator to select which data from a building is accessible/shown in the platform.

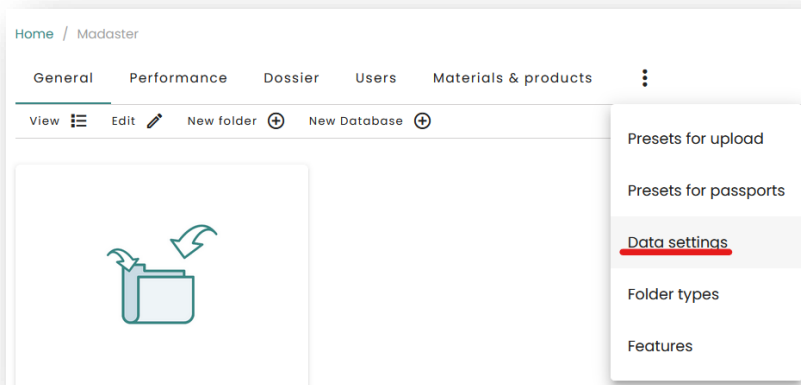

Figure 10: data settings at the account level. It is also available in folders or buildings.

This gives the following options:

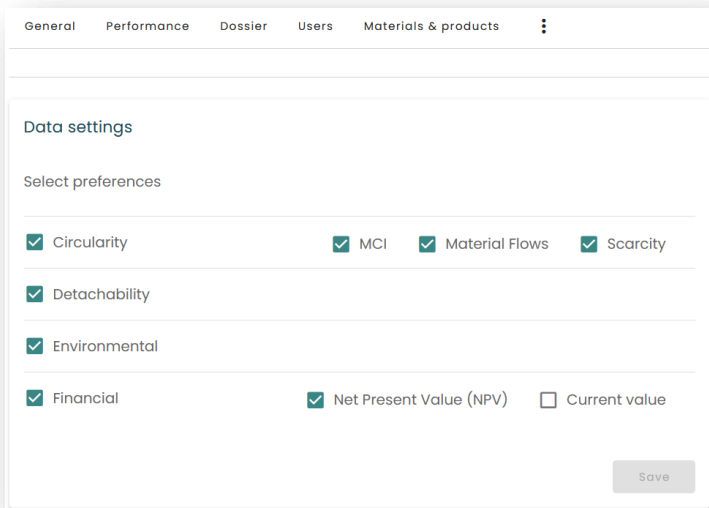

Figure 11

Unmarking and saving an option will exclude that information from being available in the platform. So if an administrator would exclude detachability, for example because it is not known or there is not enough data for it this will show up in the circularity tab in the following way:

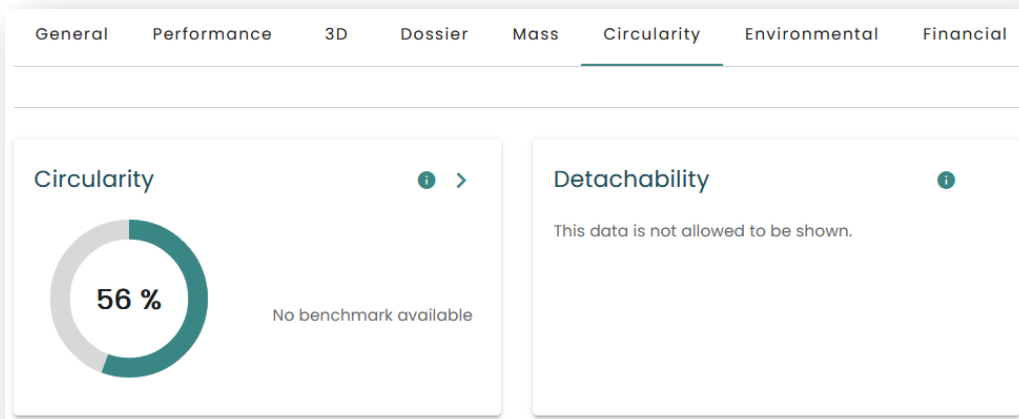

Figure 12: detachability has been excluded in the data settings

This will also impact the passport: in this case detachability will not be part of the material passport. For aggregations of data it will also be excluded; if on the data settings of a building the detachability is excluded then the detachability of that building is not taken into account for the detachability score on the account or folder that building is a part of.



The data settings are inherited from higher levels. So the building inherits the data settings from a folder, and a folder from another folder or the account. This inheritance can be broken if it is necessary to have different settings at a lower level. If no data settings are set at any level the default from the Madaster platform is used.

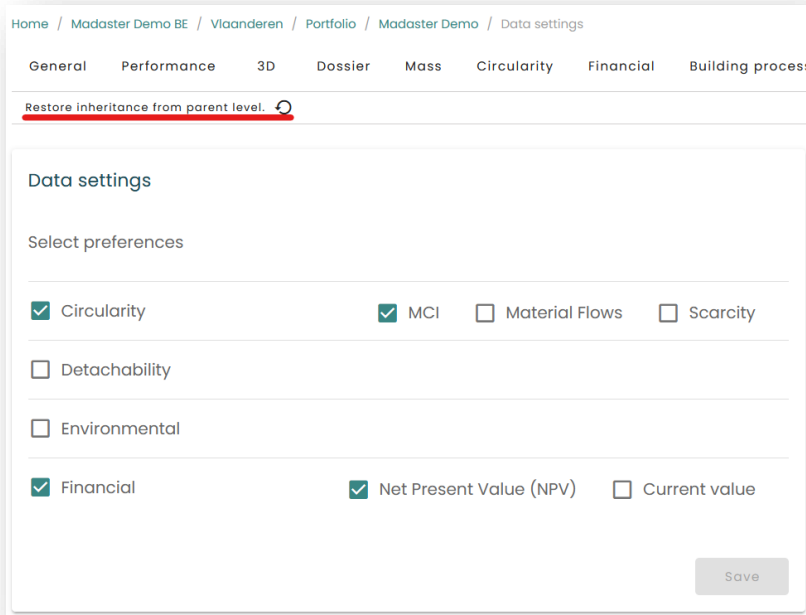
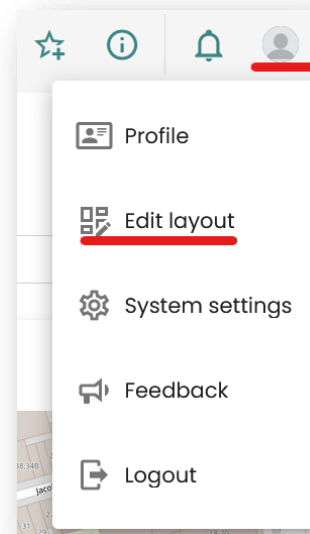

Figure 13: this building does not inherit the data settings from its parent, but it can be restored.

3.1.1.2 Edit Lay-out

As any user in the platform it is now possible to define your own preferences for which KPI's should be visible in the performance tab on account, folder or building level.





It is possible to have different settings for accounts/folders on the one hand, and buildings on the other:

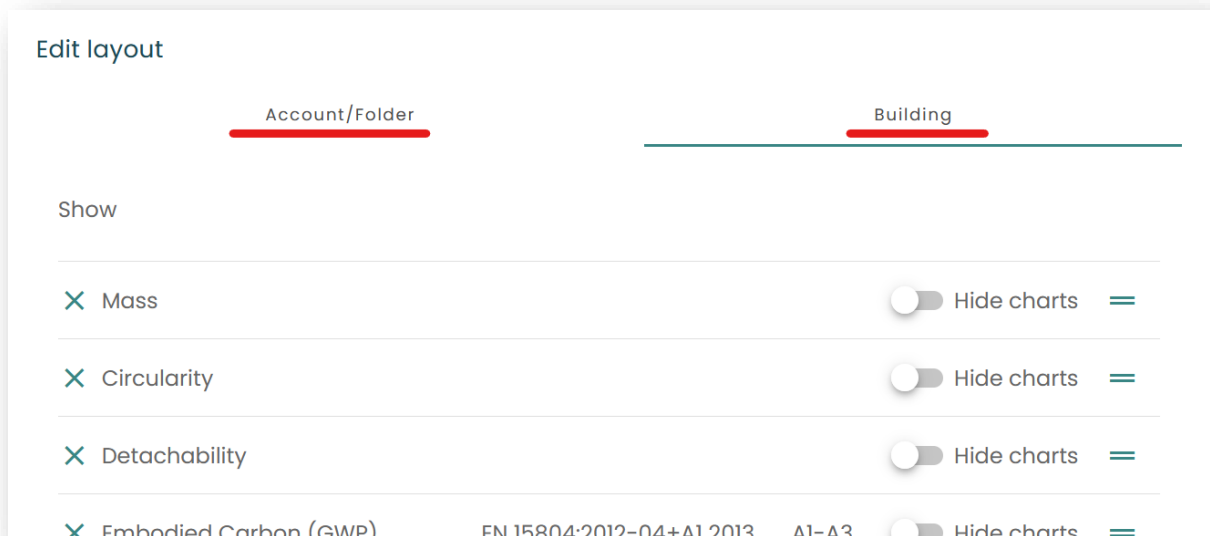

Figure 14: the edit layout screen with the building tab selected

There are a number of options in this screen:

- It is possible to include or exclude KPI's; the KPI's at 'shown' are included, the ones at 'Don't show' are not.
- It is possible to let the chart related to a KPI be shown or not
- It is possible to drag the KPI's; this will influence the sequence in which the cards are shown
- The 'Hide cards when data is not allowed' is related to the new functionality as described in 2.1.1: the option for administrators to hide data. Here it is possible exclude these cards from the overview. If included a card is shown with the message that the data is not allowed to be shown.
- Pressing the cancel button will close the screen without any changes being saved
- 'Restore default' will restore the Madaster default settings
- Save will save the changes you've made and close the screen



Edit layout

Account/Folder Building

Show

<input checked="" type="checkbox"/> Embodied Carbon (GWP)	EN 15804:2012-04+A1 2013	A1-A3	<input checked="" type="checkbox"/> Hide charts	≡
<input checked="" type="checkbox"/> Mass			<input type="checkbox"/> Hide charts	≡
<input checked="" type="checkbox"/> Circularity			<input type="checkbox"/> Hide charts	≡

Hide cards when data is not allowed.

Don't show

- Current value
- Detachability
- Net Present Value (NPV)

Environmental Compliance ▾ Phase ▾ Key Performance Indicator ▾

Cancel Restore default Save

Figure 15: a different configured lay-out for the building level

Example: for the lay-out settings as shown in figure 7 and for a building for which the environmental data has been excluded in the data settings I see the following on the performance tab of that building:



Adjust your benchmark



Figure 16: the embodied carbon is not shown because it is excluded in the data settings and I've chosen not to show cards for excluded data. Mass and circularity are shown

If I now allow environmental data to be shown for this building in the data settings it will change to this:

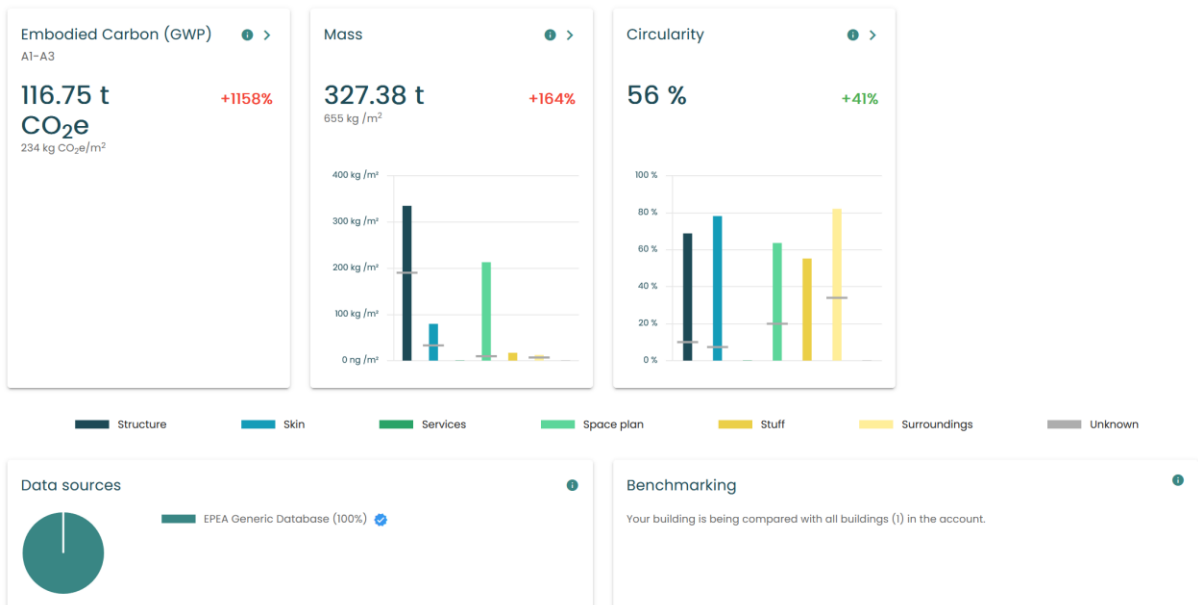

Figure 17: now the embodied carbon is shown. Since I've chosen to hide the chart for it there is no chart for it.



3.1.2 Other changes

3.1.2.1 Changes to the general and performance tabs on accounts and folders

This release a number of changes have been made to the general and performance tab on both the account and folder level. The area map has been integrated with the KPI cards on the performance tab for a better overview of the buildings in that account or folder. Furthermore; in the general tab it is now more clear in both the icon and list views which buildings have either designs, archives or have been split. Only the 'real' objects are counted (as per last release). This means that if you have for example a building with two designs the data for those designs are not aggregated in order to prevent one single real building to be included multiple times.

3.1.2.1.1 Area map integrated into the performance tab

The performance tab now has the area map integrated into it.

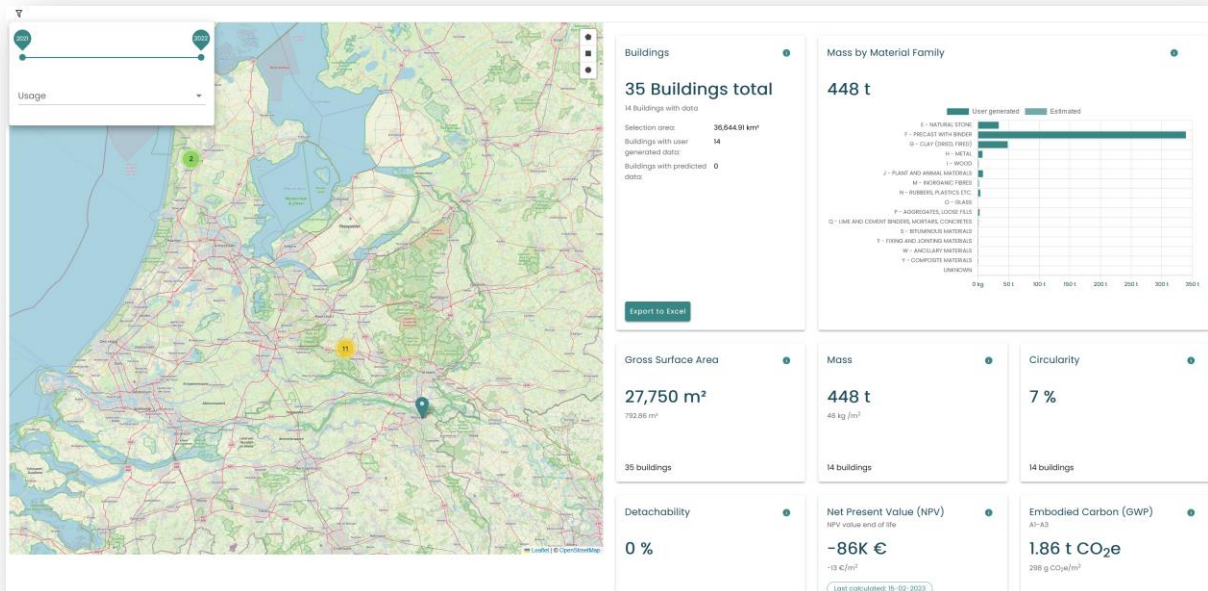

Figure 18: the performance tab with the area register



The following elements are therefore now moved from the area map to the performance tab:

- The map
- The summary card (now called 'buildings')
- The mass by material intensity card
- The filters on construction year and usage; you have to click on the filter icon in the toolbar in the top left to set these.

The selection on the map changes the scope of the calculations. To prevent the map zooming because of scrolling in the page zooming can now only be done by double clicking (which zooms in) and using the '+' and '-' icons on the map. In the cards the number of buildings which are used for the calculations is shown.

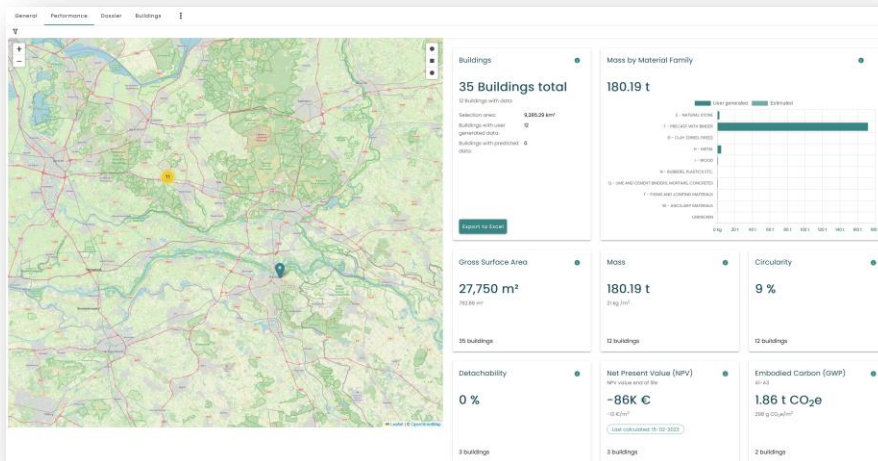

Figure 19: in this map section there are 12 buildings with data about their mass and 2 buildings with GWP data. In the buildings card it is shown that in the whole account/folder there are 35 buildings, 12 of which have data that we use in this performance tab.

Within each map segment buildings which are excluded from the calculations are:

- Designs
- Archives (unless there only is an archive)
- If a building has been split into multiple buildings all the newly split buildings are included, but the building that has been split is not



3.1.2.1.2 Visibility of designs, archives and split buildings

This release designs archives and split buildings have been removed as separate building cards from the general tab on accounts and folders. Icons have been added to buildings cards in the general tab of accounts and folders and in the list view for designs, archives and split buildings.

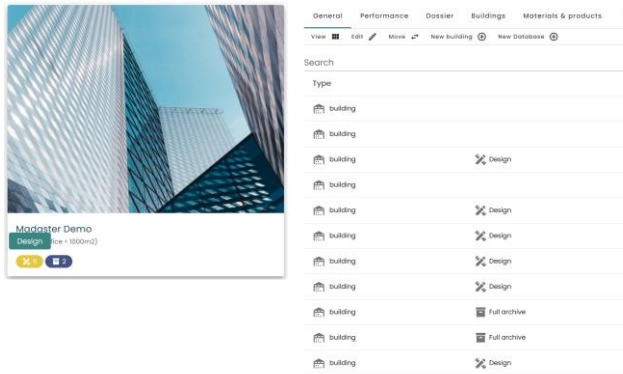

Figure 20: on the left an example of how the new icons are implemented on a building card, including the tooltip. On the right how it looks in the list view

3.1.2.2 Changes to enrichment and source file processing

There are new options for filtering in the enrichment screen:

- It is now possible to filter on the database:

Search	Element	Mat
	<input type="checkbox"/> Wand-x	Hout dam
	<input type="checkbox"/> Wand-x	Hout dam
	<input type="checkbox"/> Wand-x	ALG-
	<input type="checkbox"/> Dak-x	Dak
	<input type="checkbox"/> Wand-x	Hout dam
	<input type="checkbox"/> Wand-x	Stee
	<input type="checkbox"/> Wand-x	Stee
	<input type="checkbox"/> Wand-x	Hout dam
	<input type="checkbox"/> Wand-x	ALG-
	<input type="checkbox"/> Wand-x	Hout dam
	<input type="checkbox"/> Wand-x	Hout dam
	<input type="checkbox"/> Wand-x	Hout dam
	<input type="checkbox"/> Wand-x	ALG-
	<input type="checkbox"/> Dak-x	Dak
	<input type="checkbox"/> Vloer-x	Grin



- When the mappings have failed an alert is shown. It is also possible to filter on all the mapping mismatches. This alert is triggered when the element quantity does not match with that of the product or material. So for example when the element is described in volume whilst the product/material is described in area.

Filter on							
Element status	▼	<input type="checkbox"/>	... Ceiling grille (steel)	IPE	... Steel - Profile	1/1	
Mapping status	^	<input type="checkbox"/>	... Ceiling grille (steel)	IPE	... Steel - Profile	1/1	
<input type="radio"/> Invalid	120	<input type="checkbox"/>	... Ceiling grille (steel)	IPE	... Steel - Profile	1/1	
<input type="radio"/> Valid	112	<input type="checkbox"/>	... Toilet	unglazed tile	... Ceramic Tiles - Unglazed Porcelain	1/1	
Database	▼	<input type="checkbox"/>	... Ceiling grille (steel)	IPE	... Steel - Profile	1/1	
Building number	▼	<input type="checkbox"/>	... Toilet	unglazed tile	... Ceramic Tiles - Unglazed Porcelain	1/1	
		<input type="checkbox"/>	... Ceiling grille (steel)	IPE	... Steel - Profile	1/1	

- It is now possible to add a element description in the excel templates when uploading an excel as a source file

GTIN	ArticleNumber	Madaster Id	External Data	Description	Material/Product	Class

3.1.2.3 Additional phase groupings for LCA KPI's available

Two phase groupings for LCA have been added for use in the passports or on the performance and environmental tabs:

- Sum of the product and end-of-life phases: [A1-A3] + [C1-C4]
- Sum of all phases: A-D

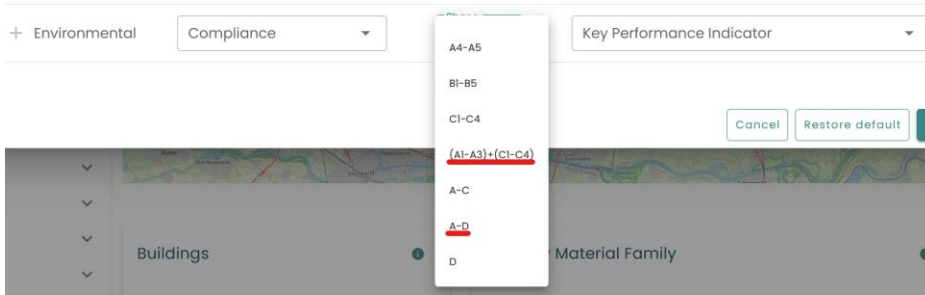

3.1.2.4 Usability changes

3.1.2.4.1 Spinning wheel

After uploading a file as long as the platform is busy processing this file a spinning wheel is shown in the dossier:

<input type="checkbox"/>	Name	Size	Classification method	Date exported	Tags	Owner	Active
<input type="checkbox"/>	Office_A_20110811.ifc 20100326_1700 (Solibri IFC Optimizer); IFC2X3	3.91 MB	NL-SfB V201912	11-08-2011 16:18		Paul Klein Lankhorst	<input checked="" type="checkbox"/>
<input type="checkbox"/>	Office_A_20110811.ifc	3.91 MB	NL-SfB	27-02-2023 09:50		Paul Klein Lankhorst	

3.1.2.4.2 Tooltips

The styling of the tooltips have been made uniform throughout the platform.

3.1.2.4.3 Show that a recalculation is done when changing the lifespan of a building

When you change the lifespan of a building a recalculation is done, this is now also shown:

Building information is being recalculated. While this process is running, no changes which affect calculations are possible on the building.



3.1.3 Bug fixes

The following bugs have been resolved:

- Saving an EPEA urban mining tool object would sometimes be stopped by an empty value which was unnecessary. This has been fixed.
- A number of checkbox bugs with the passports presets and generating material passports have been fixed.
- For smaller resolutions the tool bar could become too big, with buttons disappearing offscreen. This has been resolved.
- In the mass tab of a building, with the material family selected, the colors and offset of the chart could be wrong, what has been corrected.
- The building process tab would not open detailed information; this has been solved.



4 Build 19365

4.1 New or changed functionalities

4.1.1 New material passport options and design

In this release, the material passports have been redesigned. They have a different look and feel as well as new options. There are different types of passports now: the one-pager, an executive summary and a (full) passport that can include a technical annex with the base data in an excel file. Apart from that it is now possible to preset what data can be included in the passport, such as the Madaster Circularity Index or any of the environmental KPI's.

4.1.1.1 Issuing and generating a passport

The option to generate passports from a folder has been removed; this can now only be done from the building.

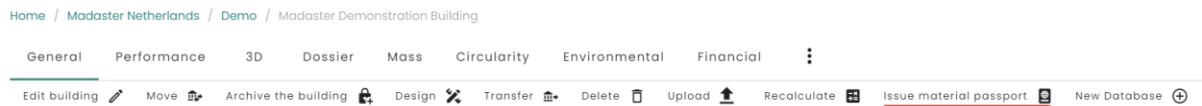

Once selected, this will open a pop-up from which it is possible to choose the type of passport to be generated for this building.

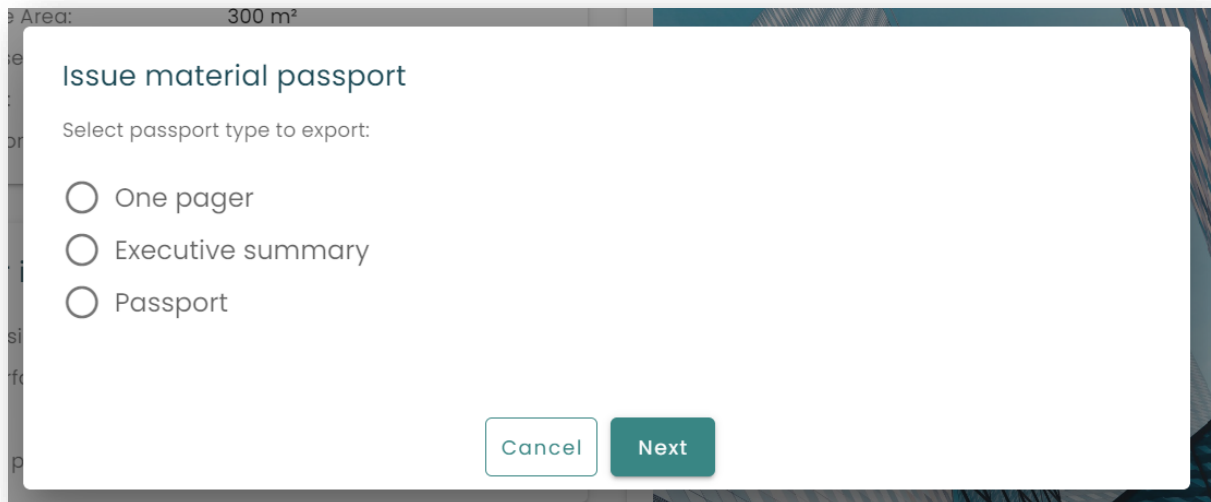

Regardless of the type, once the passport setup has been chosen a message is shown that the passport is being generated.

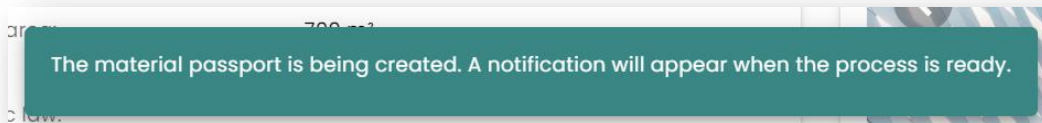

And as soon as it is ready a user notification is shown.

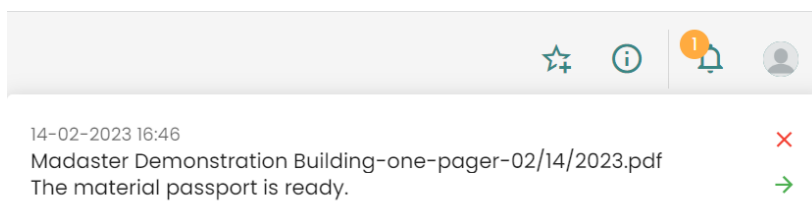

21: the notification which will appear on the top right when a passport is ready. Clicking the 'x' will remove the notification, clicking the arrow will open the dossier where the passport is located.

Which means it is available in the dossier of the building. Note that if data is unavailable for a chosen KPI or for a default field it will not appear in the passport.



4.1.1.2 One pager

The one pager passport is meant to give a concise overview of the building without too much additional insights. It can include only few items, since it needs to fit on one page. Therefore only a maximum of 5 KPI's can be included. Mass will always be included, which leaves 4 more options for configuration.

22: the one pager screen with too many KPI's selected

The one pager has the following design:

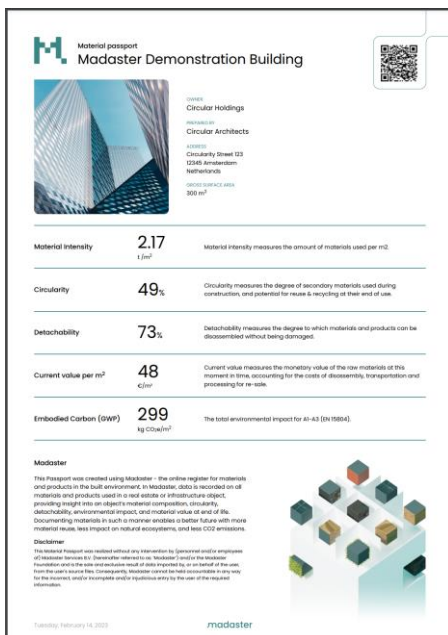

23: an example of the one pager passport. Only known data is shown. Elements like the building picture or the owner are included by default, the KPI's be chosen apart from mass – which is mandatory.



4.1.1.3 Executive summary passport

The executive summary is meant to give a lot more information than the one pager. It does not have a set maximum for the KPI's to be included.

Compliance	Phase	Key Performance Indicator	
<input checked="" type="checkbox"/> Environmental	EN 15804:2012-04_	A1-A3	Embodied Carbon (GWP)
<input checked="" type="checkbox"/> Environmental	EN 15804:2012-04_	BI-B5	Use of renewable primary energy resources used as raw ...
<input checked="" type="checkbox"/> Environmental	EN 15804:2012-04_	A-C	Abiotic Depletion Non Fossil (ADPE)
<input type="checkbox"/> Environmental	Compliance	Phase	Key Performance Indicator

But also in general it contains more detailed information.

Material passport
Madaster Demonstration Building

General information

Building	Building owner	Cadaster information
NAME Madaster Demonstration Building	NAME Circular Holdings	CADASTRAL IDENTIFICATION Amsterdam 1234
ADDRESS Circularity Street 123 12345 Amsterdam Netherlands	ADDRESS Beuse Street 123 12345 Amsterdam Netherlands	CADASTRAL SURFACE AREA 700 m ²
DELIVERY DATE 9/22/2022		OWN NUMBER 1234
BUILDING SURFACE AREA 300 m ²		
BUILDING PHASE New building		
GROUP Community (Conference complex)/mixed complex > 2000 m ²)		
Labels	Energy	
ENERGY Excellent	ENERGY CLASS A+++	
HEATING, COOLING AND VENTILATION 12 kJ/m ² y		
Lifespan		
EXPECTED LIFESPAN BUILDING (YEARS) 50		
EXPECTED LIFESPAN STRUCTURE (YEARS) 100		
EXPECTED LIFESPAN ROOF (YEARS) 20		
EXPECTED LIFESPAN SERVICES (YEARS) 15		
EXPECTED LIFESPAN SPACE PLAN (YEARS) 10		
EXPECTED LIFESPAN EQUIP (YEARS) 5		
EXPECTED LIFESPAN SURROUNDINGS (YEARS) 20		

24: In the executive summary a lot more general information from the building is shown - if available



Material passport
Madaster Demonstration Building
Source Information

Sources
Madaster primarily uses IFC building files to calculate the material quantities. To do this, you must include the "base quantities" of the objects in the report. The objects must be assigned a material property, or well as a classification code. Madaster does not calculate quantities of geometric information and all quantities are imported directly from the IFC model. On the Madaster Platform, the quality of the source files is displayed under "Source file quality". All calculations on the Madaster Platform are made within these frameworks. Consequently, any missing or/and/or incomplete and/or incorrect information in the source files immediately results in inaccurate results. Therefore, Madaster cannot warrant the quality of these results, as a secondary source of information, a Microsoft Excel file (based on a Madaster Excel template) can be imported containing geometric information about the building information on the building parts and/or components, materials, as well as classification codes.

Active Source files

Name	Classification method	Date exported
230729 DM2 - Instabuild.FC	Orniclass	8/1/2023
230729 DM2 - Instabuild.FC	Orniclass	8/1/2023
230729 DM2 - Instabuild.FC	Orniclass	8/1/2023
230729 DM2 - Constructa.FC	N-GB	8/1/2023

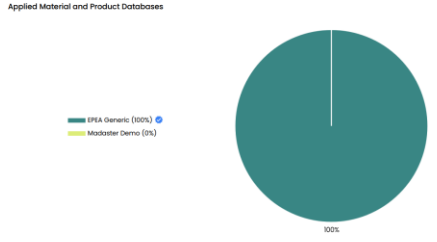

Completeness of Source Information

Category	Count	Percentage
Elements unlinked	0	0%
Elements with unknown layer	0	0%
Elements with insufficient geometry	762	23.2%

Material passport
Madaster Demonstration Building
Mass

Total mass and mass/m² demonstrate the quantity and intensity of materials temporarily stored within the building. While mass cannot be eliminated, the goal is to use less materials to achieve the same goal.

651.61 t

2.17 t/m²

Construction Materials
The building is comprised of material subfamilies, grouped into the following material families.

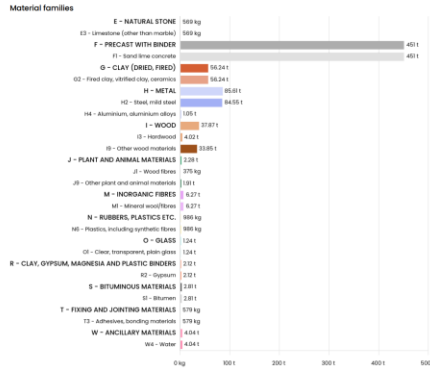

25: Source information like the classification method for the source files or the used databases is summarized. Each KPI, in this case the mass, is provided with insightful charts.

4.1.1.4 Full passport and the technical annex

The (full) passport is the most extensive passport option. It shows a lot more of the underlying data and it also has the option to include a technical annex, which is a separate excel export of the products and/or materials per shearing layer.

26: the configuration options for the full passport. It is possible to exclude the explanation about a material passport and to also generate the technical annex. Scarcity is also an additional option for the full passport, but is only available together with material flows.

An example is the mass, where it is clear from the screenshot from an example passport that it contains more detailed information about what it is and where it is located.



Material passport Madaster Demonstration Building Mass

Total mass and mass/m² demonstrate the quantity and intensity of materials temporarily stored within the building. While mass cannot be eliminated, the goal is to use less materials to achieve the same goal.

651.61 t

2.17 t/m²

Construction Materials

The building is comprised of material subfamilies, grouped into the following material families.

Material families

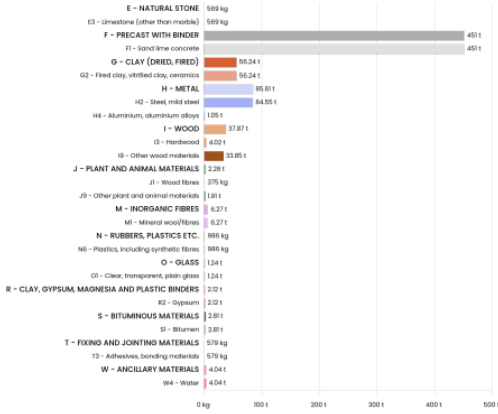

Tuesday, February 14, 2023

madaster

page 7 of 14

Material passport Madaster Demonstration Building Mass by Shearing Layer

Shearing Layers

Madaster uses the "Shearing Layers" model (Duffy, Brand, 1994) to divide a building into 6 layers: Site, Structure, Skin, Services, Space Plan, and Stuff.

Material families

The 3283 unique materials comprising the building have been grouped into 29 material families.

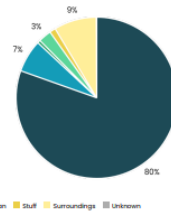

Layer Composition

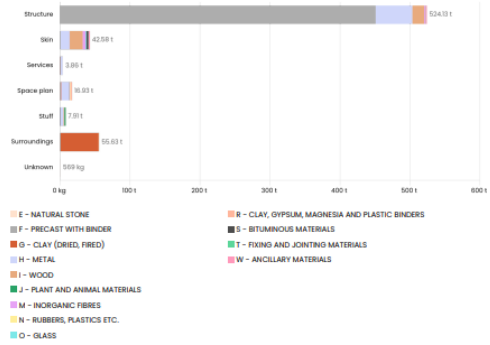

Tuesday, February 14, 2023

madaster

page 8 of 14

Material passport Madaster Demonstration Building Mass by Material Families

Material families

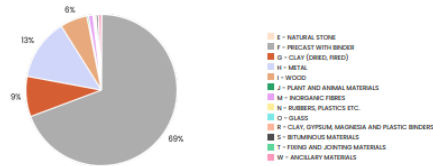

Material Family Allocation Across Building Shearing Layers

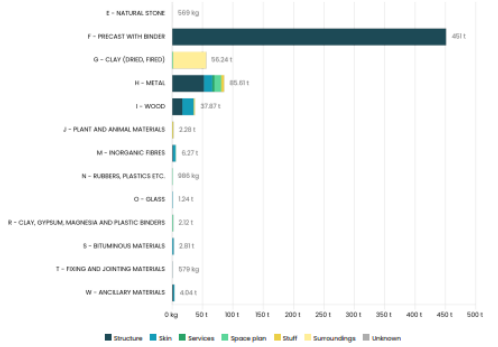

Tuesday, February 14, 2023

madaster

page 9 of 14

Material passport Madaster Demonstration Building Mass details

Material family	Total	Structure	Skin	Services	Space plan	Stuff	Surroundings	Unknown
E - NATURAL STONE	0%	0%	0%	0%	0%	0%	0%	0%
E3 - Limestone (other than marble)	0%	0%	0%	0%	0%	0%	0%	0%
F - PRECAST WITH BINDER	69.2%	69.2%	0%	0%	0%	0%	0%	0%
F1 - Sand lime concrete	69.2%	69.2%	0%	0%	0%	0%	0%	0%
G - CLAY (DRIED, FIRED)	8.6%	0%	0%	0%	0.2%	0%	8.4%	0%
G2 - Fired clay, vitrified clay, ceramics	8.6%	0%	0%	0%	0%	0%	8.4%	0%
H - METAL	13.7%	8%	2%	0.8%	1.7%	0.7%	0%	0%
H2 - Steel, mild steel	13%	8%	2%	0.8%	1.7%	0.7%	0%	0%
H4 - Aluminum, aluminum alloys	0.2%	0%	0%	0%	0%	0%	0%	0%
I - WOOD	4.02%	1.8%	1.92%	0%	0%	1.21%	0%	0%
I3 - Hardwood	0.6%	0%	0.3%	0%	0%	1.21%	0%	0%
I9 - Other wood materials	3.2%	1.8%	1.6%	0%	0%	0%	0%	0%
J - PLANT AND ANIMAL MATERIALS	0.4%	0%	0%	0%	0%	0.3%	0%	0%
J1 - Wood fibres	0.3%	0%	0%	0%	0%	0%	0%	0%
J9 - Other plant and animal materials	0.1%	0%	0%	0%	0%	0%	0%	0%
M - INORGANIC FIBRES	7%	0.2%	0.6%	0%	0%	0%	0%	0%
M1 - Mineral wool/fibres	7%	1.48%	4.03%	0%	0%	0%	0%	0%
N - RUBBERS, PLASTICS ETC.	0.2%	0%	0%	0%	0%	0%	0%	0%
N9 - Plastics, including synthetic fibres	0.2%	0%	0%	0%	0%	0%	0%	0%
O - GLASS	1.24%	0%	1.24%	0%	0%	0%	0%	0%
O1 - Clear, transparent, plain glass	1.24%	0%	1.24%	0%	0%	0%	0%	0%
R - CLAY, GYPSUM, MAGNESIA AND PLASTIC BINDERS	0.3%	0%	0%	0%	0.3%	0%	0%	0%
R2 - Gypsum	0.3%	0%	0%	0%	0.3%	0%	0%	0%
S - BITUMINOUS MATERIALS	2.81%	0%	2.81%	0%	0%	0%	0%	0%
S1 - Bitumen	2.81%	0%	2.81%	0%	0%	0%	0%	0%
T - FIXING AND JOINTING MATERIALS	0.4%	0%	0.4%	0%	0%	0%	0%	0%
T3 - Adhesives, bonding materials	0.4%	0%	0.4%	0%	0%	0%	0%	0%
W - ANCILLARY MATERIALS	4.04%	0%	4.04%	0%	0%	0%	0%	0%
W4 - Water	4.04%	0%	4.04%	0%	0%	0%	0%	0%

Tuesday, February 14, 2023

madaster

page 10 of 14

27: Mass in the full passport. An additional page with mass details is excluded here for the sake of brevity



Another KPI, circularity, in the full passport contains not just the MCI, but also information about how it is calculated, as well as circularity by either shearing layer or phase.

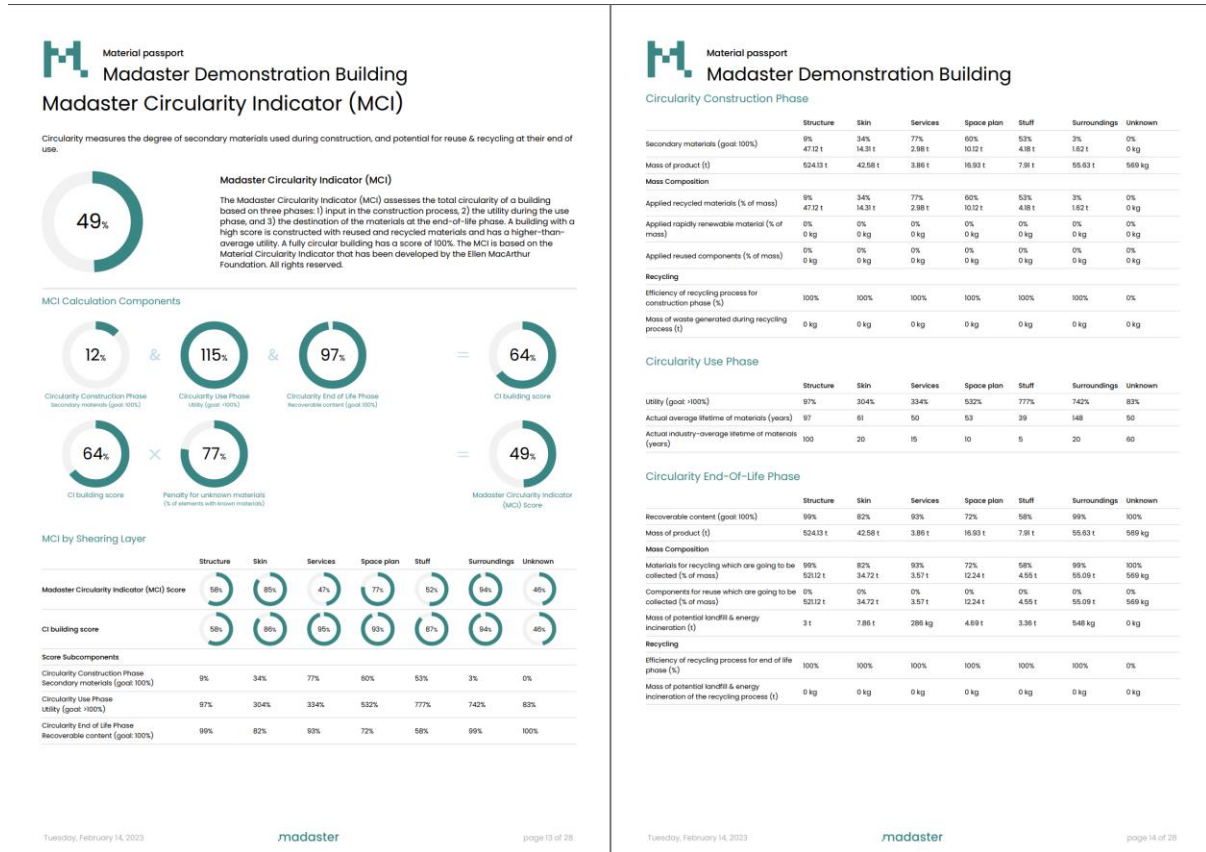

When one has opted for also generating the technical annex a separate excel file will be placed in the dossier of the building. This annex will be filled with the materials or products divided in separate sheets for each shearing layer. The columns for each product/material are dependent on which KPI's have been chosen for the passport.



Classification Level 1	Classification Level 2	Classification Level 3	Is mapped	Material/Product	Insulation (kg)	Madaster Circularity Indicator (MCI)	Detachability Indicator	Embodied Carbon (GWP)	Use of non-renewable primary energy
21-01-00-00 Substructure	21-01-10 Foundations	21-01-10-10 Standard Foundations	TRUE	Oak wood	0	18	0%	-26,0041995	0%
2 STRUCTURE PRIMARY ELEMENTS	28 Building frames	28-11 hoofddragestructuur, kolommen en liggers	TRUE	Steel - Profile	222	0	84%	22312,62045	84%
4 STRUCTURE PRIMARY ELEMENTS	21 External walls	21-20 buitenwanden, constructief opbouwvlak	TRUE	Porous Concrete	0	0	34%	27020420454	34%
5 STRUCTURE PRIMARY ELEMENTS	23 Floors	23-20 vloeren, constructief, algemeen (verwarmd/niveau)	TRUE	Mineral wool (pitched roof insulation)	480	0	0%	2294,20842	0%
6 STRUCTURE PRIMARY ELEMENTS	23 Floors	23-20 vloeren, constructief, vrijgevalde vloeren	TRUE	Reinforced concrete C25/30 (2% Reinforcement)	0	0	57%	40994,20202	57%
7 GROUND SUBSTRUCTURE	16 Retaining walls, foundations	16-0 funderingsconstructies, algemeen	TRUE	Reinforced concrete C25/30 (2% Reinforcement)	0	0	57%	11884,4803	57%
8 STRUCTURE PRIMARY ELEMENTS	28 Building frames	28-11 hoofddragestructuur, kolommen en liggers, kolom-/liggerconstructies	TRUE	Reinforced concrete C25/30 (2% Reinforcement)	0	0	57%	204,620791	57%
9 STRUCTURE PRIMARY ELEMENTS	21 External walls	21-20 buitenwanden, constructief, massieve wanden	TRUE	Steel Laminated Timber	384	0	43%	-24386,09485	43%
10 GROUND SUBSTRUCTURE	17 Pile Foundations	17-10 funderingsconstructies, algemeen	TRUE	Reinforced concrete C25/30 (2% Reinforcement)	0	0	57%	2147,363557	57%

28: two different excel annexes from the same building with differently chosen KPI's

4.1.1.5 Passport presets

Since it is now possible to select the data you want to include in the passport, functionality has been added to preset your own default KPI's. This can only be done by the Madaster administrator. The presets are available on account, folder and building level. Normally only the presets at the account level are available, but it is possible to break this inheritance in case the presets at a lower level should be different.

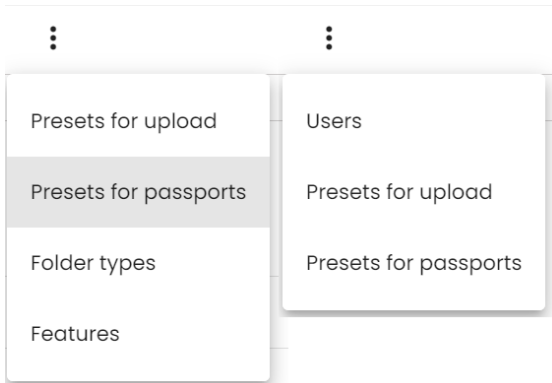

29: presets for passports can be picked at the three vertical dots on accounts, folders or buildings

In this screen it is possible to add a new preset

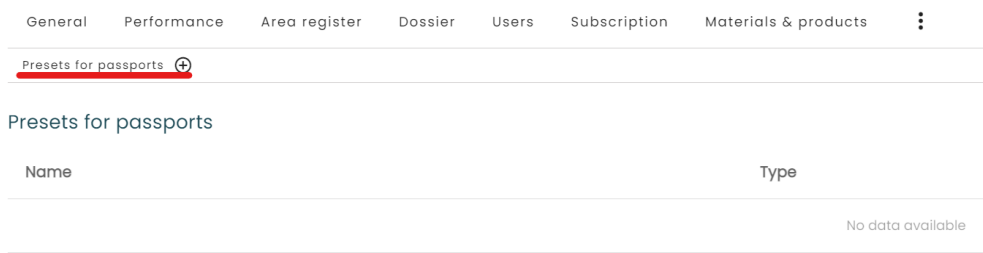



Once clicked a new popup will open where it is possible to define this new preset. All the options for the KPI's you have on the regular passport screen can be filled in here as well as a name for your preset and of course for which passport type it is.

This new preset will then be an option when you generate a new passport of that type

30: Options at the top of the screen for generating a passport. "Default" is the default from the Madaster platform.

Now, to have different presets on for example the building level it is possible to break the inheritance



General Performance 3D Dossier Mass Circularity Environmental Financial ⋮

Break inheritance

Presets for passports

Name	Type
One pager Madaster	One pager

Rows per page: 10 1-1 of 1 < >

This will make a copy of the current presets, but they can be edited or deleted

Presets for passports

Name	Type	
One pager Madaster	One pager	

It is also possible to restore the inheritance. This will, however, delete the presets on this level.

Presets for passports **Restore inheritance from parent level.**

Presets for passports

Name	Type
One pager Madaster	One pager

4.1.1.6 Generate passport options when splitting, transferring or archiving

It is possible to generate a passport when splitting, transferring or archiving buildings



Split the building

Prefix for building name (Will be concatenated with Building Number) *

Split test

Choose building numbers *

Choose passport types to generate

One pager

Executive summary

Passport

Language

 English

Cancel

Split



4.1.2 Other changes

4.1.2.1 New feature: 3D insights on circularity and environmental tabs of a building

A new feature has been added to the platform, which when bought will give 3D insights on circularity and environmental information of the materials/products of a building.

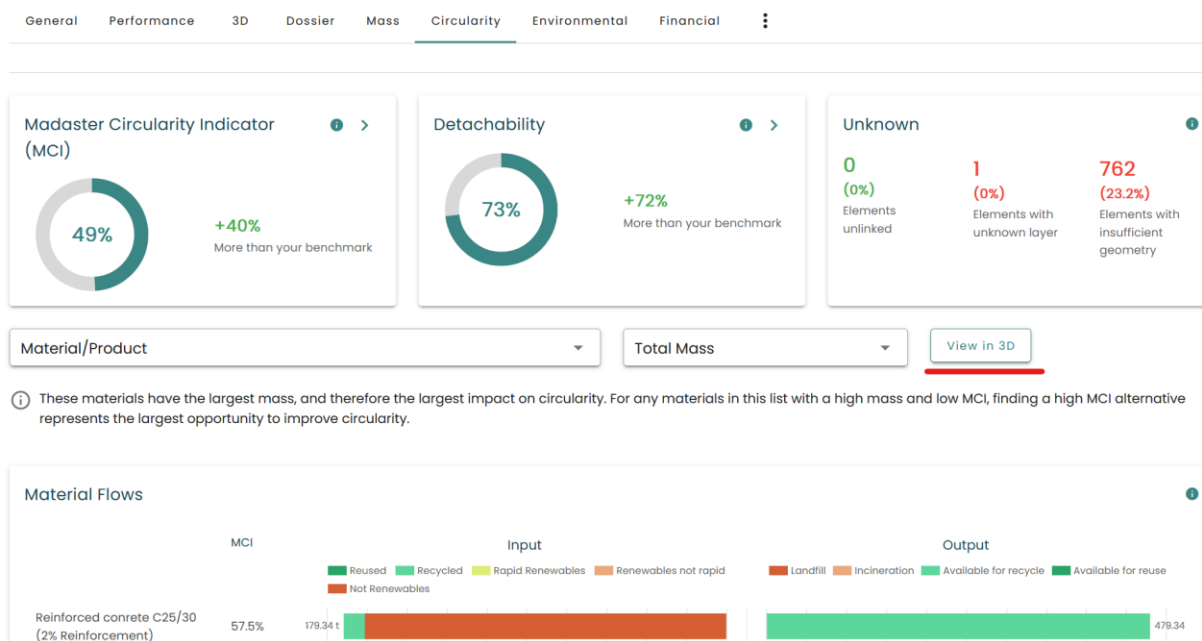

Figure 31: in the circularity and environmental tabs it is now possible to view the materials/products in the 3D model by using this button



Material/Product Total Mass View Graph

i These materials have the largest mass, and therefore the largest impact on circularity. For any materials in this list with a high mass and low MCI, finding a high MCI alternative represents the largest opportunity to improve circularity.

<input checked="" type="checkbox"/>	Name	Mass	Madaster Circularity Indicator (MCI) Score
<input checked="" type="checkbox"/>	Reinforced concrete C25/30 (2% Reinforcement)	479.34 t	57.48%
<input checked="" type="checkbox"/>	Facing bricks / Clinkers (NL)	54.76 t	94.12%
<input checked="" type="checkbox"/>	Steel - Profile	54.56 t	92.15%
<input checked="" type="checkbox"/>	Glued Laminated Timber	36.76 t	64.59%
<input checked="" type="checkbox"/>	Mineral wool (pitched roof insulation)	5.51 t	54.72%
<input checked="" type="checkbox"/>	Bituminous sheeting	2.81 t	40%
<input checked="" type="checkbox"/>	Beech wood	2.79 t	82%
<input checked="" type="checkbox"/>	Gypsum Fibre Plate	2.5 t	82%
<input checked="" type="checkbox"/>	Cotton sheet	1.91 t	55%
<input checked="" type="checkbox"/>	Plywood Board	1.72 t	82%

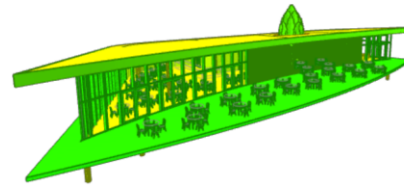



Figure 32: when using the 3D button the graph will change to the 3D model where it is also possible to select certain materials or products. With the view graph button it will switch back to the graph.

The 3D insights can be bought from the subscription tab on the account.

Choose Features



3D Viewer insights
350 per year

When the feature is not active a preview is shown when clicking the 'view in 3D button' in the circularity or environmental tabs.

Material/Product Total Mass View Graph

i These materials have the largest mass, and therefore the largest impact on circularity. For any materials in this list with a high mass and low MCI, finding a high MCI alternative represents the largest opportunity to improve circularity.

<input checked="" type="checkbox"/>	Name	Mass	Madaster Circularity Indicator (MCI) Score
<input checked="" type="checkbox"/>	Zyrkonite	278.36 t	0%
<input checked="" type="checkbox"/>	Plaster board	47.56 t	0%
<input checked="" type="checkbox"/>	Plywood Board	14.18 t	32.5%
<input checked="" type="checkbox"/>	Cabinet of Wonders	256 kg	73%
<input checked="" type="checkbox"/>	Buffalo Bill oM	191.71 kg	0%

Interested in 3D Insights?
Buy the '3D Viewer' feature to enable this functionality.

[Subscription](#)

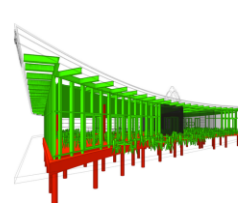

Rows per page: 10 1-5 of 5

4.1.2.2 Designs, archived and split buildings in the performance tab and area register

For the calculations on the performance tab on folder, account level or in the area register, and also for which buildings are shown in the area register a number of objects are excluded:



- Designs of buildings
- Archives of buildings
- If a building is split: the original

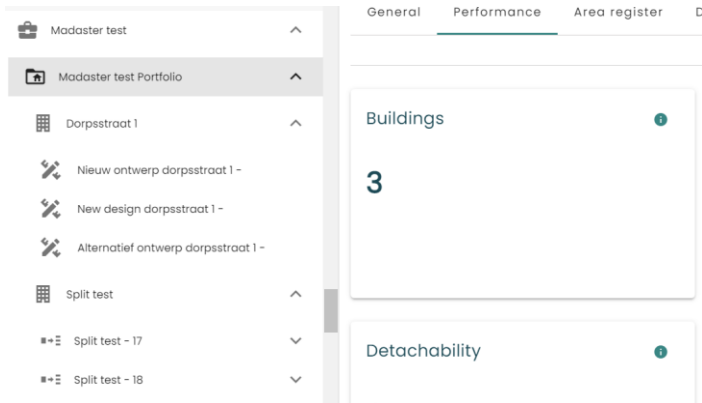

33: Two buildings, one of them is split, results in 3 buildings in the performance tab and for calculations and in the area register.

4.1.2.3 Changes to benchmarking on the performance tab of a design or archive

It is now possible to change your benchmark settings in the performance tab on a design or archived building to compare it with other specific buildings, for example other designs:

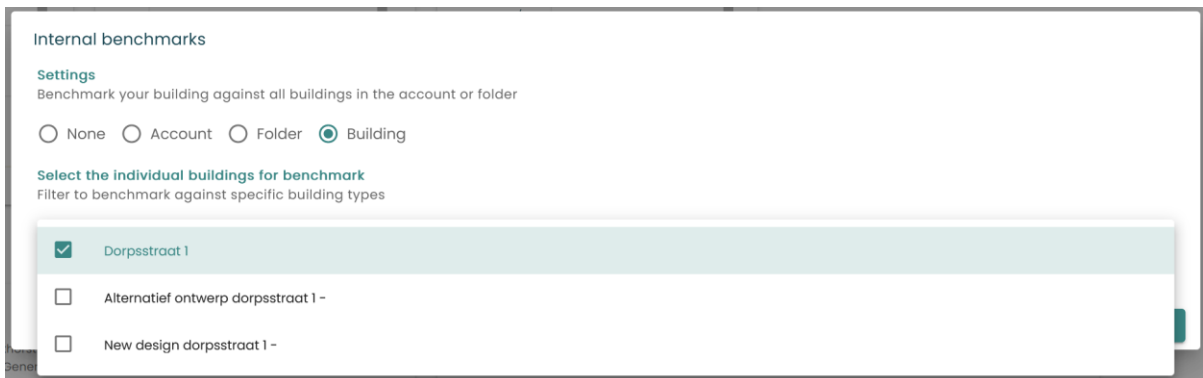

This selection is visible on the performance tab itself



Benchmarking

Your building is being benchmarked against the following 1 buildings:

Dorpsstraat 1

4.1.2.4 Changes to the calculations for LCA stage B4 (use stage: replacement)

The lifespan of a product connected to a building is now taken into account in relation to the lifespan of the whole building. This means that if a product is expected to be replaced four times during the lifespan of the building this is taken into account for the calculations in the replacement use stage.

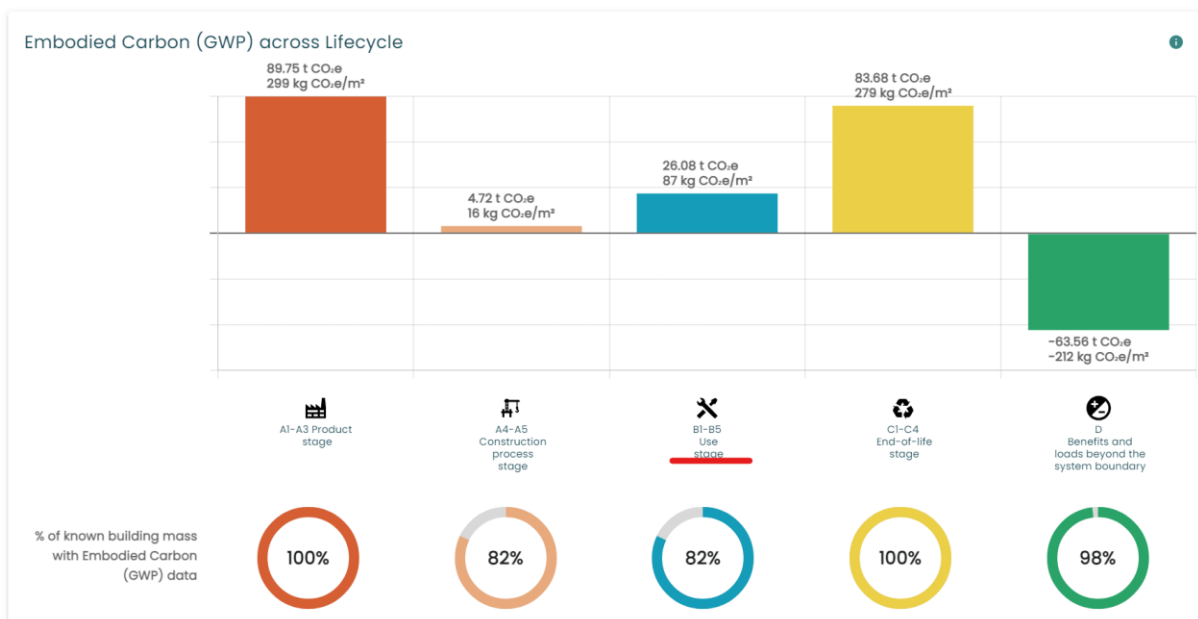

Figure 34: a building with an expected lifespan of 60 years

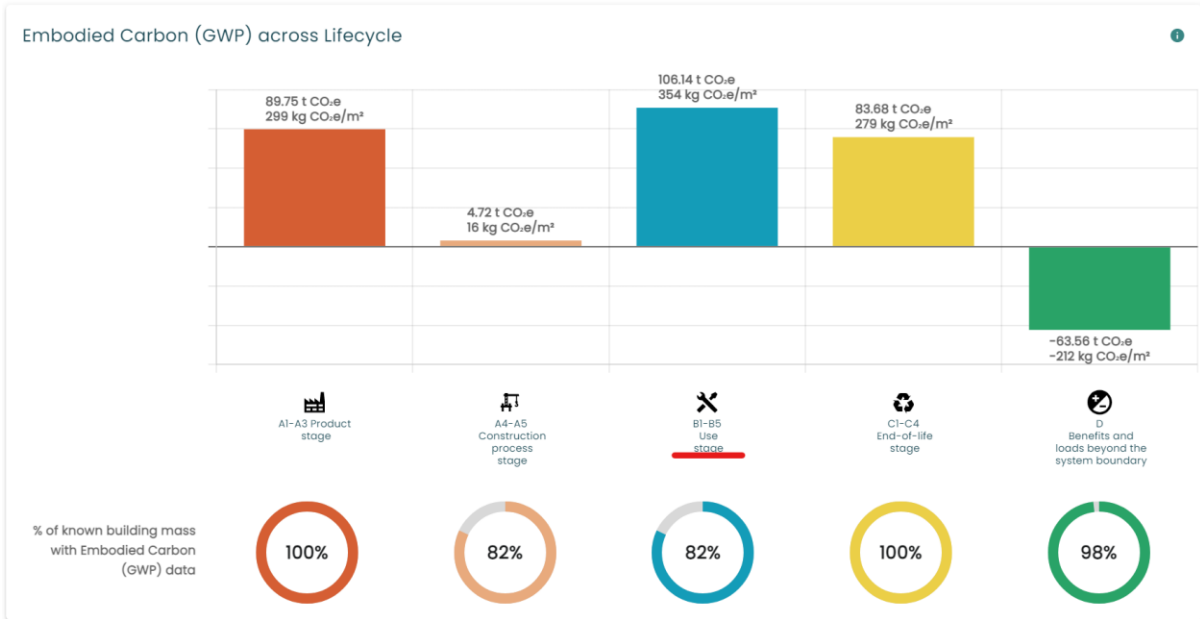

Figure 35: the same building as in figure 12; but now with an expected lifespan of 120 years

4.1.2.5 Additional information at the MCI detail view

When clicking on the MCI details two new columns have been added:

- The penalty for unknown materials
- Madaster Circularity Indicator (MCI) Score

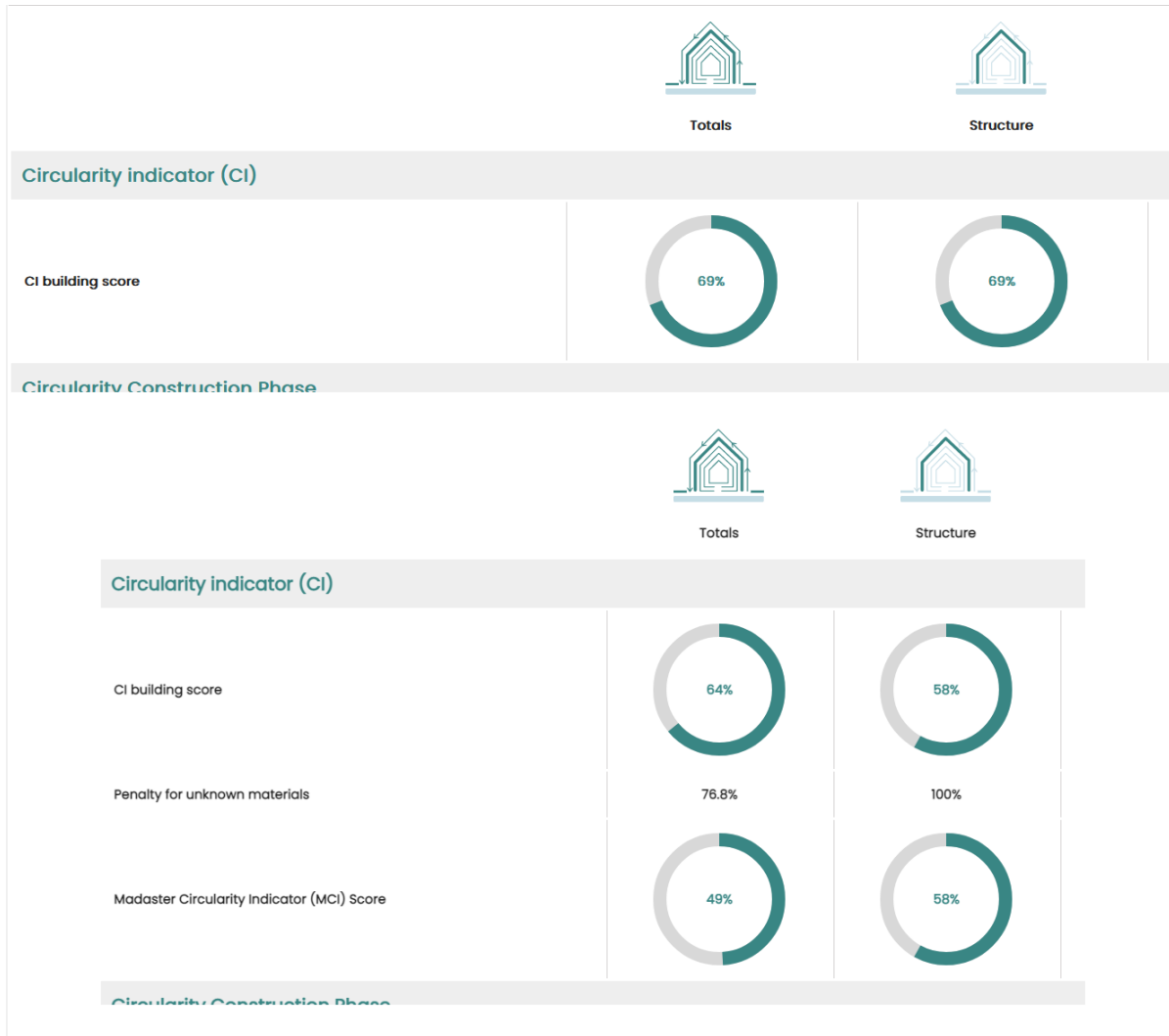

Figure 36: on top how it was, on the bottom what it is now.

4.1.2.6 Split building can now be activated

The split building feature used to be only accessible through invitation, this has been changed

4.1.2.7 "See more" at database information

To indicate that there is more text a '...see more' has been added to the database information field



Database information



The EPEA Generic database enables country-specific, full-building calculations regarding material composition (mass), circularity, and embodied carbon (kg CO₂e).
The database, which is expert-rev ...[see more](#)

4.1.2.8 Billing information shown when modifying a subscription

When a subscription is modified, the current known billing information is shown:

Billing Information

Billing email:

Company name:

att.:

Refence / PO number:

Address:

I agree that the billing information is correct

If the above billing information is not correct, please [contact us](#). before proceeding with the sub

4.1.2.9 Database selection when uploading files for a building

The EPEA generic database is now the default when uploading a file for a building. We've removed the blue checkmark for the Madaster database.



Add file

Indicate to which sources in the Madaster platform the elements in the file to be uploaded should automatically be linked and in which order this should be done per element. To add or remove a source, select the '+' or 'X' sign at the end of a source name.

Available sources		Selected sources	
NMD	+	EPEA Generic	X
Madaster	+	Lankhorst B.V.	X
2BA	+		
Hook Producer	+		
MRPI	+		
IBU DATA	+		
ECOPLATFORM	+		
ENVIRONDEC	+		
ÖKOBAUDAT 2019-	+		

4.1.2.10 Possibility to change the name of the account

It is now possible to change the name of an account in Madaster by using the edit button in the general tab of an account. This will only change the name in the platform, so not for billing or other purposes.

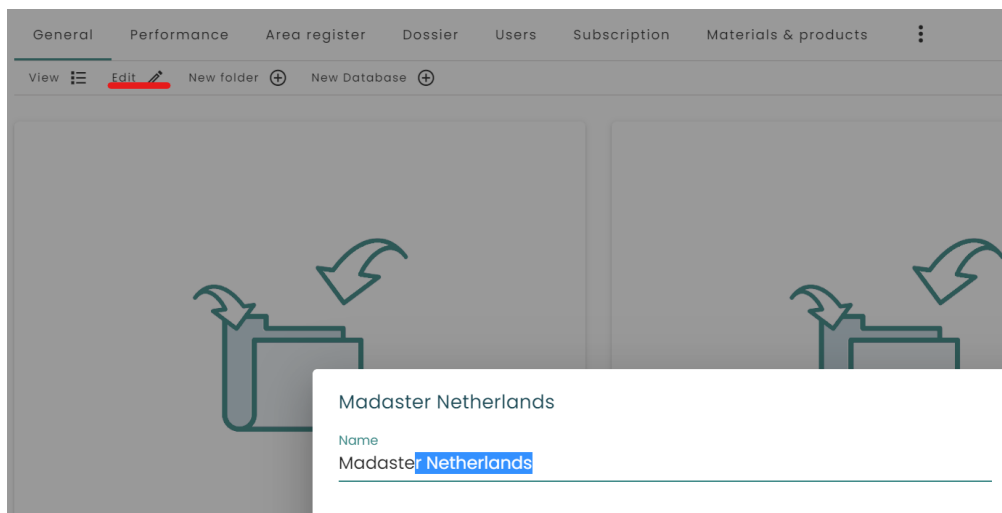

4.1.2.11 Additional Madaster V2 classification

There is now an additional option for the Madaster V2 classification when adding or editing a material in a database and when enriching.



Material information Circularity Environment Search criteria Fin

Save Close

Material name *

Kryptonite

Specific weight *

5,000

kg/m³

Madaster

Unknown

Madaster V2 *

Z - OTHER

4.1.2.12 Slice a 3D model

In the 3D viewer of a building it is now possible to slice it.

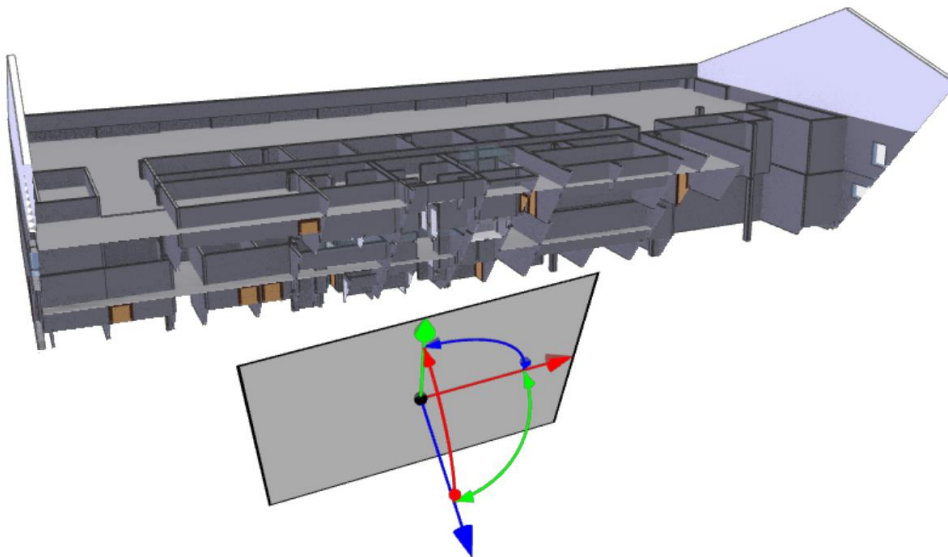



4.1.2.13 The 'bill of materials' for circularity is unchecked by default

If you would add a product to a database in Madaster the default was to use the bill of materials for the circularity data, this has been changed.

The image shows two side-by-side screenshots of the Madaster product form, illustrating a change in the default settings for calculating circularity and density values from the Bill of Materials (BoM).

Left Screenshot (Old Situation):

- Product information tabs: Product information, Circularity, Environment, Search cr
- Buttons: Save, Close
- Section: General
- Fields: Product name*, Type*, Volume, Product code, GTIN, Functional lifespan (years) (0, Year)
- Checkbox: Do not calculate circularity values from Bill of Materials
- Checkbox: Calculate environmental values from Bill of Materials

Right Screenshot (New Situation):

- Product information tabs: Product information, Circularity, Environment, Search cri
- Buttons: Save, Close
- Section: General
- Fields: Product name*, Type*, Volume, Product code, GTIN, Functional lifespan (years) (0, Year)
- Checkbox: Calculate circularity and density values from Bill of Materials
- Section: Madaster
- Table:

Name	Type
No data available	

Density* kg/m³

- Checkbox: Calculate environmental values from Bill of Materials

Figure 37: on the left the old situation, on the right the new one

4.1.2.14 Color changes in the charts

A number of charts have been given different colors in line with our new design which was introduced not long ago.

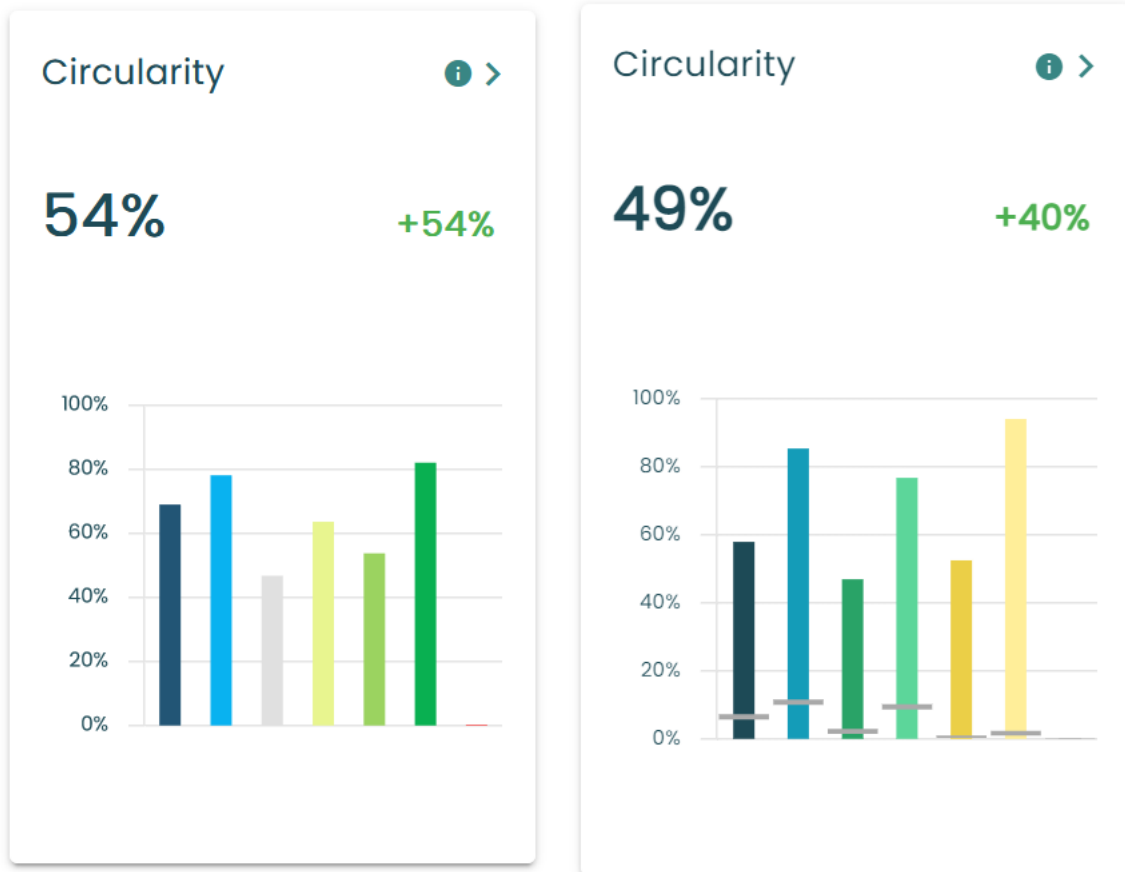

Figure 38: on the left the old color scheme and on the right the new one. One of many charts that have changed colors.

4.1.2.15 Changes on building and folder type fields

- The manual or indicative MPG score is now shown in €/m².jr instead of €/m²

Labels

BREEAM:

Manual MPG score:

Excellent

12 €/m².jr

- There are new fields for the owner on a building



Owner

Owner
Circular Holdings

Address line 1
Reuse Street 123

Address line 2

Postal code
12345

City
Amsterdam

Country
Netherlands

General Performance 3D Dossier Mass Circularity En

Edit building Move Archive the building Design Transfer

Address

Circularity Street 123
12345 Amsterdam
Netherlands

Owner

Owner: Circular Holdings
Address: Reuse Street 123
12345 Amsterdam
Netherlands

39: The new owner fields. Left how they are when editing a building, on the right what they look like in the general tab of the building

- Because of the addition of the owner field on the building the fields 'specify owner in passport' and 'owner label in passport' have been removed from folder type.

- Fields for 'prepared by' and 'design stage' have been added. The design stage is filled using the level of detail (LOD).



Madaster information

Prepared by
Circular Architects

Design Stage
Unknown

- Design Stage
Unknown
- LOD 100 - Concept Design
 - LOD 200 - Schematic Design
 - LOD 300 - Detailed Design
 - LOD 350 - Construction Documentation
 - LOD 400 - Fabrication & Assembly
 - LOD 500 - As-Built

General Performance 3D Dossier Mass Circularity Envirc

Edit building Move Archive the building Design Transfer Del

Address

Circularity Street 123
12345 Amsterdam
Netherlands

Owner

Owner: Circular Holdings
Address: Reuse Street 123
12345 Amsterdam
Netherlands

Madaster information

Prepared by: Circular Architects
Design Stage: Unknown

- It is now possible to choose any country at the address for a building

Address

Use map to create a location

Street

Circularity Street

House number

123

House number suffix

Postal code

12345

City

Amsterdam

Country

- Afghanistan
- Åland Islands
- Albania
- Algeria
- American Samoa
- Andorra

- It is now possible to allow search criteria for a folder type:



New Folder type

Name *
Complex

Description

Plural Name
Complexes

Foldertype allowed directly under account?

Buildings can be added in this folder type

Does folder of this folder type requires an address?

Folder of this type is a region defined by spatial coordinates?

Allow search criteria

Allowed folder types in subfolders
Complex Portfolio Project

Icon
mdi-domain

Logo

Cancel Save

4.1.2.16 Changes in navigation

- When at a dossier on a building the source files are now a 'folder', and when you select a folder only the files from that specific folder are shown. It used to be that the source files were always kept on top, which is still the case when no folders are selected. Also, the sequence of the folders has been changed.

General Performance 3D Dossier Mass Circularity Environmental Financial

Upload

Filter on

Keyword

Source file (BIM or Excel)

Keyword	Name	Size	Classification method	Date exported	Tags	Owner	Active	
Consumer dossier	220729 DM2 - Installaties.ifc IFC file generated by GRAPHISOFT ARCHICAD 25.0.0 NED FULL Macintosh version (IFC add-on version: 4017 NED FULL); IFC2X3	108.26 MB	Omniclass	01-08-2022 18:11		Michiel Lankamp	<input checked="" type="checkbox"/>	
Source files	220729 DM2 - Bouwkundig.ifc IFC file generated by GRAPHISOFT ARCHICAD 25.0.0 NED FULL Macintosh version (IFC add-on version: 4017 NED FULL); IFC2X3	19.85 MB	Omniclass	01-08-2022 18:14		Michiel Lankamp	<input checked="" type="checkbox"/>	
Passports	220729 DM2 - Interieur.ifc IFC file generated by GRAPHISOFT ARCHICAD 25.0.0 NED FULL Macintosh version (IFC add-on version: 4017 NED FULL); IFC2X3	14.84 MB	Omniclass	01-08-2022 17:50		Michiel Lankamp	<input checked="" type="checkbox"/>	
Contractual agreements	220729 DM2 - Constructie.ifc IFC file generated by GRAPHISOFT ARCHICAD 25.0.0 NED FULL Macintosh version (IFC add-on version: 4017 NED FULL); IFC2X3	6.91 MB	NL-SfB	01-08-2022 19:15		Michiel Lankamp	<input checked="" type="checkbox"/>	

General document

Name	Size	Last modified ↓	Tags	Owner	
Madaster Demonstration Building-technical-annex-02/14/2023.xlsx	26.29 kB	14-02-2023 20:15		Paul Klein Lankhorst	
Madaster Demonstration Building-passport-02/14/2023.pdf	30.86 MB	14-02-2023 20:15		Paul Klein Lankhorst	

40: the view when no folders are selected. The source files are on top and the other documents below.



General Performance 3D Dossier Mass Circularity Environmental Financial

Upload

Filter on

Keyword

Consumer dossier

Source files

Passports

Contractual agreements

Usage, Maintenance & Renov...

Tags

Name	Size	Last modified	Tags	Owner
Madaster Demonstration Building-technical-annex-02/14/2023.xlsx	26.29 kB	14-02-2023 20:15		Paul Klein Lankhorst
Madaster Demonstration Building-passport-02/14/2023.pdf	30.86 MB	14-02-2023 20:15		Paul Klein Lankhorst
Madaster Demonstration Building-executive-summary-02/14/2023.pdf	28.58 MB	14-02-2023 19:55		Paul Klein Lankhorst
Madaster Demonstration Building-passport-02/14/2023.pdf	30.90 MB	14-02-2023 19:52		Paul Klein Lankhorst
Madaster Demonstration Building-technical-annex-02/14/2023.xlsx	39.48 kB	14-02-2023 18:29		Paul Klein Lankhorst
Madaster Demonstration Building-passport-02/14/2023.pdf	33.21 MB	14-02-2023 18:29		Paul Klein Lankhorst
Madaster Demonstration Building-executive-summary-02/14/2023.pdf	29.05 MB	14-02-2023 17:46		Paul Klein Lankhorst
Madaster Demonstration Building-one-pager-02/14/2023.pdf	27.24 MB	14-02-2023 16:46		Paul Klein Lankhorst
Madaster Demonstration Building-one-pager-02/13/2023.pdf	27.24 MB	13-02-2023 17:31		Paul Klein Lankhorst
Madaster Demonstration Building-one-pager-02/13/2023.pdf	27.24 MB	13-02-2023 16:52		David Parker

Rows per page: 10 1-10 of 62

41: once a folder is selected only the files from that folder are shown.

- In the building tabs “Users” and “Presets for Upload” (and the newly introduced “Presets for Upload” have been placed as additional options under three vertical dots

Home / Madaster Netherlands / Demo / Madaster Demonstration Building

General Performance 3D Dossier Mass Circularity Environmental Financial

Edit building Move Archive the building Design Transfer Delete Upload

Address

Circularity Street 123
12345 Amsterdam
Netherlands

Open Street Map

Users
Presets for upload
Presets for passports

- For new users the left navigation is pinned by default

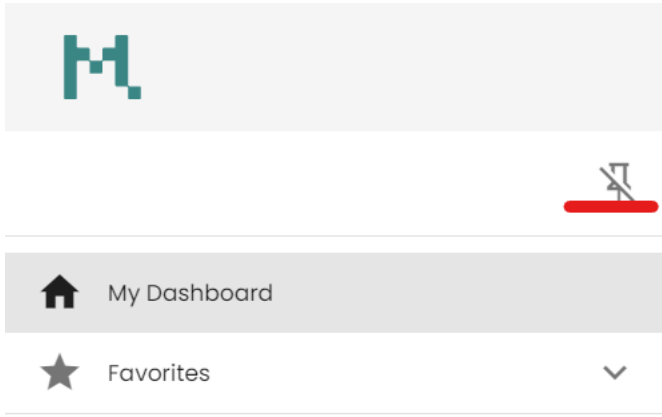

- Linking to specific results on the circularity or environmental tab

It is now possible to copy an URL that contains the specific filters on the circularity or environmental tab.

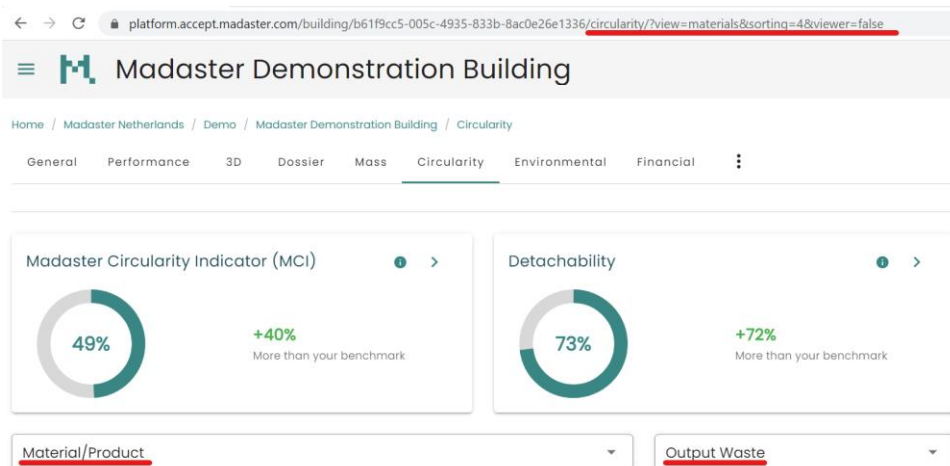

- Users with regular authorizations will no longer see the user tab
- The option to create a design or archive a building have been removed for home-owners



- When a user enters the platform with no recent items on 'my dashboard' a welcome text is shown:

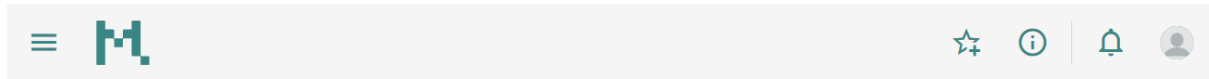

Welcome to Madaster

Madaster is an innovative platform that provides an easy way to register, manage and analyze the materials used in your construction projects. We believe that to achieve a circular construction industry, materials must be centrally registered so they can again become resources in the future. Thank you for taking this important first step.

Things look a little empty, but not for long!

We've put together a user guide for you to create objects, enrich them with data, and view and share their performance.

[Get started](#)

4.1.3 Bug fixes

The following bugs have been resolved:

- When transferring a building the authorizations on the transferred building were set wrong, this has been adjusted so that the authorizations are set correctly on the transferred building.
- Rounding has been adjusted so that for example 2 kt of CO2e as displayed on the performance tab for GWP can now be displayed with two decimals (i.e. 1,7)
- In the mass tab of a building at 'unknown' the values would sometimes incorrectly be '0', this has been fixed.
- When creating a new design the notification when this design is ready would mention that the archive was ready. This has been fixed so that it correctly mentions design.
- Deleting a design would mention that the whole building would be deleted where it would only delete the design, this has been textually adjusted so that it mentions only deleting the design.
- We found some wrong mappings in the Omniclass classification, these have been corrected.